

SEGA®

<http://www.replacementdocs.com>

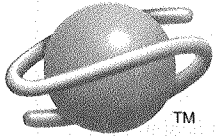

INSTRUCTION MANUAL

SEGA SATURN™



**READ THIS INSTRUCTION MANUAL
BEFORE USE AND RETAIN IT FOR
FUTURE REFERENCE.**



672-3721C



EPILEPSY WARNING

Please read before using this video game system or allowing your children to use it.

Some people are susceptible to epileptic seizures or loss of consciousness when exposed to certain flashing lights or light patterns in everyday life. Such people may have a seizure while watching certain television images or playing certain video games. This may happen even if the person has no medical history of epilepsy or has never had any epileptic seizures.

Certain conditions may induce undetected epileptic symptoms even in persons who have no prior history of seizures or epilepsy.

If you or anyone in your family has ever had symptoms related to epilepsy (seizures or loss of consciousness) when exposed to flashing lights, consult your doctor prior to playing.

We advise that parents should monitor the use of video games by their children. If you or your child experience any of the following symptoms: dizziness, blurred vision, eye or muscle twitches, loss of consciousness, disorientation, any involuntary movement or convulsion, IMMEDIATELY discontinue use and consult your doctor.

FOR YOUR HEALTH

- Sit a good distance away from the television screen, preferably as far away as the length of the Control Pad cable allows.
- Avoid playing if you are tired or have not had much sleep.
- Make sure that the room in which you are playing is well lit.
- Rest for at least 10 minutes per hour while playing a video game.

CONTENTS

3.....	Warnings and Precautions
6.....	About Your Sega Saturn
7.....	Sega Saturn Peripherals
7.....	The Sega Saturn Unit
8.....	Connecting the Sega Saturn
9.....	The Video Connection!
12.....	The Sega Saturn Control Pad
13.....	Easy Start!
15.....	Control Screens and Button Functions
19.....	Backup Functions and System Settings
20.....	Advanced CD Functions
21.....	Troubleshooting
22.....	Sega Saturn Hardware Information
23.....	Limited Warranty



WARNING

- **Do not expose the Sega Saturn to water, rain or moisture, as this can result in electric shock or fire.**
- **Do not disassemble or alter the Sega Saturn and Sega Saturn peripherals in any way.**
No parts inside the unit can be serviced by the user. Misuse of the Sega Saturn in this way may lead to electric shock and damage to the unit. If you have a problem, contact your Sega dealer.
- **The Sega Saturn console operates at 120 volts.**
Using incorrect voltage can result in a risk of electric shock, fire or damage to the unit.
- **Disconnect the power when connecting the Sega Saturn.**
Unplug the Power Cord when connecting the Sega Saturn. Also ensure that the television and VCR to which the Sega Saturn is connected are switched off. If you do not, it may cause electric shock.
- **Turn off the Sega Saturn when not in use.**
Leaving the Sega Saturn with the power on may constitute a risk of fire.
- **Lightning:**
For added protection for the Sega Saturn during a lightning storm, or when it is left unattended and unused for long periods of time, unplug it from the wall socket and disconnect the antenna or cable system. This will prevent damage due to lightning and power-line surges.
- **Object and Liquid Entry:**
Never push objects of any kind into the console through openings, as they may touch dangerous voltage points or short out parts that could result in fire or electric shock. Never spill liquids of any kind on the product.
- **Ventilation:**
Slots and openings in the console are provided for ventilation, to ensure reliable operation and to protect the Sega Saturn from overheating. Do not cover your Sega Saturn during use as heat may build up internally.
- **Keep the lithium battery out of the reach of children.**
If a child swallows a lithium battery, consult a doctor immediately. Failure to comply with this can result in a risk of suffocation or poisoning.
- **Do not let small children stick their fingers in any openings on the Sega Saturn console.**
Misuse of the Sega Saturn in this way may lead to electric shock and damage to the unit.

The following marks appear on the underside of the Sega Saturn unit.



This symbol (the lightning flash with arrow symbol, within an equilateral triangle) is intended to alert the user to the presence of uninsulated dangerous voltage within the product's enclosure that may be of sufficient magnitude to constitute a risk of electric shock to persons.

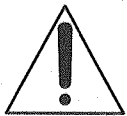

This symbol (the exclamation point within an equilateral triangle) is intended to alert the user to the presence of important operating and maintenance (servicing) instructions in the literature accompanying the product.

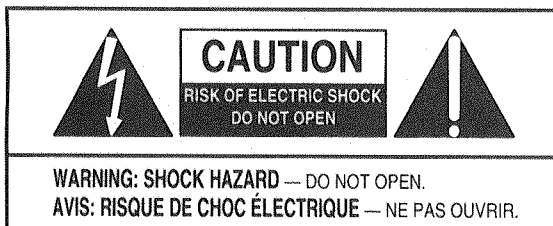

To reduce the risk of electric shock, do not remove the cover. No parts inside the console can be serviced by the user. If you have a problem, contact your Sega dealer.

Pour réduire les risques de choc électrique, ne pas retirer le couvercle. Aucune pièce à l'intérieur de la console ne peut être réparée par l'utilisateur. En cas de problème, contacter le revendeur Sega.

IMPORTANT FOR LASER PRODUCTS

- THE SEGA SATURN IS A **CLASS 1 LASER PRODUCT**
The F.D.A. Department of Health and Human Services defines Class 1 Lasers as devices which emit radiation levels "below which biological hazards have not been established."
- Caution—use of controls, adjustments or performance of procedures other than those specified herein may result in hazardous radiation exposure.

PRECAUTIONS FOR USE

Be sure to read the accompanying Safeguards Sheet entitled "Important Safety Instructions" before using your Sega Saturn for the first time.

Disconnect the power when connecting the Sega Saturn.

Unplug the Power Cord when connecting the Sega Saturn. Also ensure that the television and VCR to which the Sega Saturn is connected are switched off. If you do not, it may cause electric shock.

Turn off the Sega Saturn when not in use.

If the Sega Saturn is left on for extended periods of time, heat buildup causes risk of fire and deterioration of components.

Lightning:

For added protection for the Sega Saturn during a lightning storm, or when it is left unattended and unused for long periods of time, unplug it from the wall socket and disconnect the antenna or cable system. This will prevent damage due to lightning and power-line surges.

Object and Liquid Entry:

Never push objects of any kind into the Sega Saturn through openings, as they may touch dangerous voltage points or short out parts that could result in fire or electric shock. Never spill liquids of any kind on the product.

Ventilation:

Slots and openings in the Sega Saturn are provided for ventilation, to ensure reliable operation and to protect the Sega Saturn from overheating. Do not cover your Sega Saturn during use as heat may build up internally.

Damage Requiring Service:

Unplug the Sega Saturn from the wall socket and refer servicing to qualified personnel under the following conditions.

- (a) If the Power Cord or plug is damaged;
- (b) If liquid has been spilled or objects have fallen into the Sega Saturn;
- (c) If the Sega Saturn has been exposed to rain or water;
- (d) If the Sega Saturn does not operate normally despite following the operating instructions; Adjust only those controls that are covered by the operating instructions as an improper adjustment of other controls may result in damage and will often require extensive work by a qualified technician to restore the product to its normal operation.
- (e) If the Sega Saturn has been dropped or damaged in any way;
- (f) If the Sega Saturn exhibits a change in performance - this indicates a need for service.

Location

- Avoid the following conditions during use or storage: high temperatures, such as direct sunlight or near a heater; extreme cold; steam vapour, such as near a kitchen stove; dust; areas where the machine may be splashed with water; humidity; slanted, unstable or vibrating surfaces.
- Condensation may accumulate on the surface of the unit if it is subjected to sudden changes in temperature. In this case, allow the unit to rest for about one hour before use.

Console

- Do not drop the Sega Saturn or any other parts or subject them to shock.
- When cleaning the Sega Saturn, do not use benzene, thinner or any other strong chemicals. Use a moist cloth for cleaning.
- Do not use any software peripheral equipment that was not specifically designed for the Sega Saturn. Look for the Sega Seal of Quality.
- Do not disconnect the Control Pad or any other peripheral during gameplay as it may result in malfunction.
- Do not let the terminals get dirty, as it can damage the Sega Saturn. If they do get dirty, wipe with a soft, dry cloth.

CD Drive

- Do not open the CD door when a CD is playing.
- Do not use excessive force when opening the CD door.
- Do not touch the lens inside the CD door. If the lens is dirty, wipe it with a soft, dry cloth.
- Always close the CD door to avoid accumulation of dust.
- Make sure there is no CD in the CD drive when moving the Sega Saturn.

Power Cord and Supply

- Do not forcibly bend or pull the Power Cord.
- Do not place heavy objects on the Power Cord.
- Hold the Power Cord by the plug when disconnecting.
- Do not allow the plug or terminals to come into contact with metallic objects or water.
- Use only the Power Cord supplied with the Sega Saturn.
- Never use the Power Cord with any other products as it can cause damage.
- Never touch the plug with wet hands as it may result in electric shock.

Lithium Battery

- Make certain the positive side of the lithium battery is facing upward.
- Do not disassemble, heat, charge or ignite the battery.
- When the battery is low, replace it as soon as possible. A run-down battery adversely affects the performance of the Sega Saturn.
- Wipe the surface of the lithium battery before use.

FCC WARNING

This product generates and uses radio-frequency energy. Interference to radio and TV reception may be caused if not used according to these instructions. The Sega Saturn complies with the limits for a Class B digital device, pursuant to Part 15 of the FCC Rules. These limits are designed to provide reasonable protection against harmful interference in a residential installation. However, there is no guarantee that interference will not occur in a particular installation. If this equipment does cause harmful interference to radio or television reception, which can be determined by turning the equipment off and on, the user is encouraged to try to correct the interference by one or more of the following measures:

- Reorient or relocate the receiving antenna.
- Increase the distance between the Sega Saturn and receiver.
- Connect the Sega Saturn into an outlet on a circuit different from that to which the receiver is connected.
- Consult the dealer or an experienced radio/TV technician for help.

Important

Please note that changes or modifications not expressly approved by the party responsible for FCC compliance may void the user's authority to operate the equipment. Please check with the manufacturer prior to effecting any changes or modifications to the Sega Saturn. Please also note that the Sega Saturn Power Cord, which is included, is made of shielded wire. If cable other than that supplied with the Sega Saturn is used, there is a possibility of violating FCC emission limits. Such change or modification of the Sega Saturn is prohibited. Use only the included shielded Sega Saturn Power Cord when setting up and using the Sega Saturn system. If necessary, the user should consult the dealer or an experienced radio/TV technician for additional suggestions. The user may find the following booklet prepared by the Federal Communications Commission helpful: How to Identify and Resolve Radio-TV Interference Problems. This booklet is available from the U.S. Government Printing Office, Washington, DC., 20402, Stock No. 004-000-00345-4.

Note to Owners of Projection Televisions

Still pictures or images may cause permanent picture-tube damage or mark the phosphor of the CRT. Avoid repeated or extended use of video games on large-screen projection televisions. Consult your owner's manual before playing video games on your projection television.

GAMEPLAY ASSISTANCE AND INFORMATION

For expert help on gameplay and other assistance, call the Sega experts at:
1-900-200-SEGA

<p>1-900-200-SEGA</p> 	<p>Learn SEGA game secrets from the masters. Call Now.</p> <p>U.S.: 1-900-200-SEGA \$.95/min (recorded), \$1.50/min (live) Must be 18 or have parental permission. TDD Phone required. Sega of America Canada: 1-900-451-5252 US \$1.50/min (recorded/live)</p>
--	---

For exciting information on upcoming Sega Saturn products, please call **1-800-SEE-SATURN (1-800-733-7288)** or e-mail Sega at webmaster@sega.com If you're on the World Wide Web, check us out at <http://www.sega.com> and on CompuServe we're at **GO SEGA**. See you there!

Note: The Sega Saturn is for personal use only, not for commercial use. This Sega Saturn is only for use with NTSC televisions purchased in North and South America (excluding Argentina, Paraguay and Uruguay), and will not operate with other televisions.

ABOUT YOUR SEGA SATURN

Sega Saturn is the most powerful home gaming system ever built, and takes you beyond the limits of conventional gaming. Sega Saturn brings home the most realistic sports and arcade gameplay and 3D worlds yet. Its multifunctional abilities allow you to enjoy a full multimedia entertainment experience.

Your Sega Saturn package should contain the following components:

Manual of instructions (this booklet)
Safeguards sheet
Sega Saturn unit
Sega Saturn Control Pad
Sega Saturn Stereo A/V Cable

Sega Saturn Power Cord
Sega Saturn sticker
Warranty card
Lithium battery (CR2032 inserted, with insulation sheet)

About The Lithium Battery

The lithium battery (type CR2032) powers the internal backup memory and clock. Change the battery about once a year. Before replacing the battery, switch off the power to the Sega Saturn unit and unplug the Power Cord. Wipe the upper surface of the battery with a dry cloth before installing.

Replacing the Battery

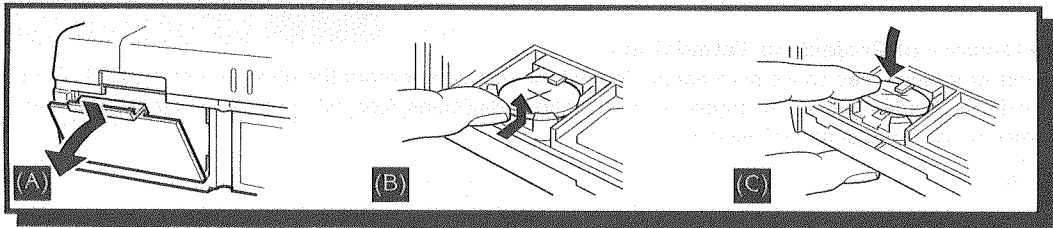

- (A) Remove the Battery Cover.
(B) Remove the battery.
(C) Insert a new battery, keeping the positive side upwards, and close the Battery Cover.

Caution

The lithium battery may explode if mistreated. Do not recharge, disassemble or dispose of in fire.

When replacing the battery, use only Panasonic, Sanyo or JIL recognized or listed CR2032 models. Use of other types of battery may present risk of fire or explosion.

Notes

- If you start a game with no battery installed or if the battery power is too low, you can not save game data.
- When you remove the lithium battery, *all saved data is erased*. To keep data while replacing the lithium battery, purchase a Sega Saturn Backup RAM Cartridge.
- Make sure to remove the insulation sheet beneath the lithium battery before use, or you won't be able to use the Sega Saturn's internal memory.

You can use an array of software on your Sega Saturn:

- Sega Saturn game CDs
- Audio CDs
- CD+G (audio with graphics) discs
- CD+EG (audio with extended graphics) disks
- 8-centimeter audio CD singles

Note: You cannot use Genesis, Sega CD or Genesis 32X games or their peripheral equipment with your Sega Saturn.

SEGA SATURN PERIPHERALS

This is just a sample of the exciting Sega Saturn peripherals available now at your Sega dealer. And there's more on the way!



Control Pad
MK-80116

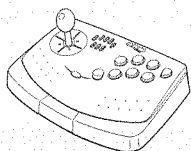

Virtua Stick
MK-80112

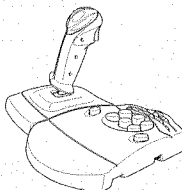

Mission Stick
MK-80104

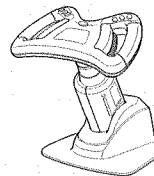

Arcade Racer
MK-80107

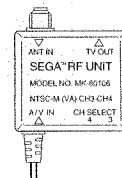

RF Unit
MK-80106

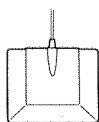

6Player Adaptor^{*}
MK-80102



Mouse
(Coming Soon)

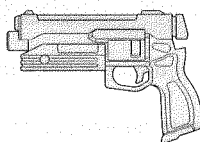

Stunner
MK-80113

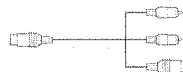

S-Video Cable
(Coming Soon)

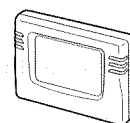

Backup RAM Cartridge
MK-80101

Note: To purchase a Sega Saturn RF Unit or any Sega Saturn peripheral, please call **1-800-SEE-SATURN**, or visit your local retailer.

THE SEGA SATURN UNIT

Front View

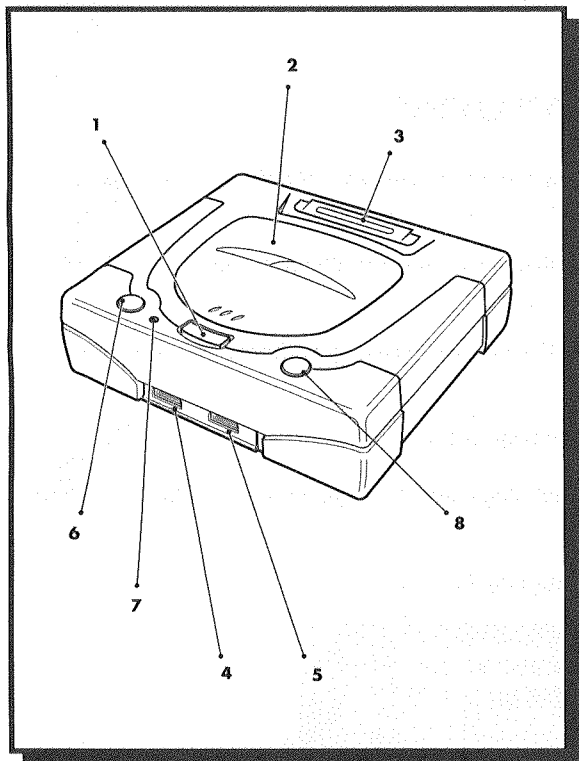

1. Press the **OPEN** button to open the CD door.
2. Insert a CD in the unit and close the **CD Door**.
3. The **Cartridge Slot** is used to insert accessories, such as the Backup RAM Cartridge.
4. Plug in a Sega Saturn Control Pad or other Sega Saturn peripherals in **Control Port 1**.
5. Use **Control Port 2** to connect a Control Pad or other peripherals for multi-player games.
6. Press the **POWER** button to switch the power on and off.
7. The **Power Light** lights up when power is on.
8. Press the **RESET** button to restart a game.

Rear View

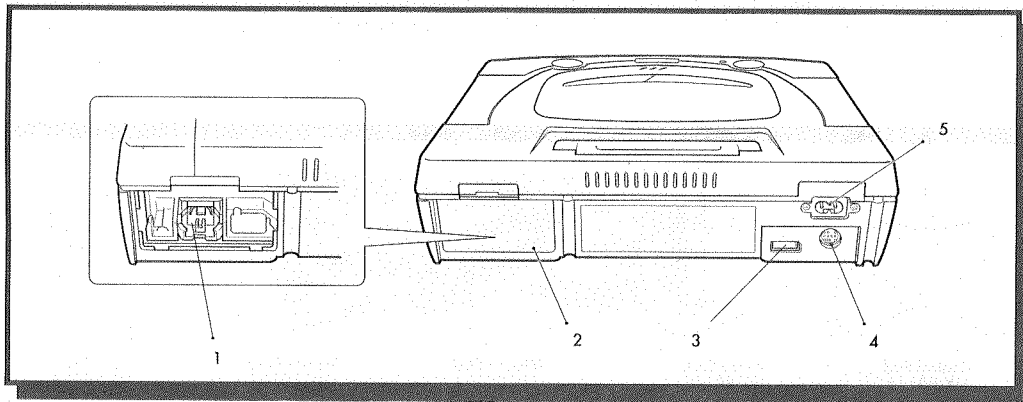

1. The **lithium battery** powers the Sega Saturn backup memory.
2. Remove the **battery cover** in order to remove/replace the lithium battery, remove the insulation sheet, or insert the Video CD Adaptor (sold separately).
3. Interface with your Sega Saturn by using future Sega technologies through the **Communications Jack!**
4. Plug the Stereo A/V Cable (included) into the **A/V OUT Plug**.
5. Plug the Power Cord (included) into the **Power Plug**.

CONNECTING THE SEGA SATURN

- *Make sure that your Sega Saturn is turned off and unplugged from the electric socket before connecting any power cables.*
- Remove the battery cover and pull out the plastic insulation sheet protecting the lithium battery. If you do not, you won't be able to use the Sega Saturn's internal memory.
- Connect the AV cables according to the type of TV or TV/VCR set-up you have in your home (see *The Video Connection!* page 9).
- Connect the Sega Saturn Control Pad to Control Port 1 on the Sega Saturn.
- Attach the Power Cord directly to the AC power source. Do not plug it into the Sega Saturn until the power source is firmly connected.
- See *Easy Start!* (page 13) on how to start using the Sega Saturn right away!

THE VIDEO CONNECTION!

Connecting to a TV or VCR with A/V Input

If your TV or VCR has audio/video input jacks, use the supplied Stereo A/V Cable to connect your Sega Saturn. If the TV only has monaural sound, connect **only** the white audio jack and the yellow video jack.

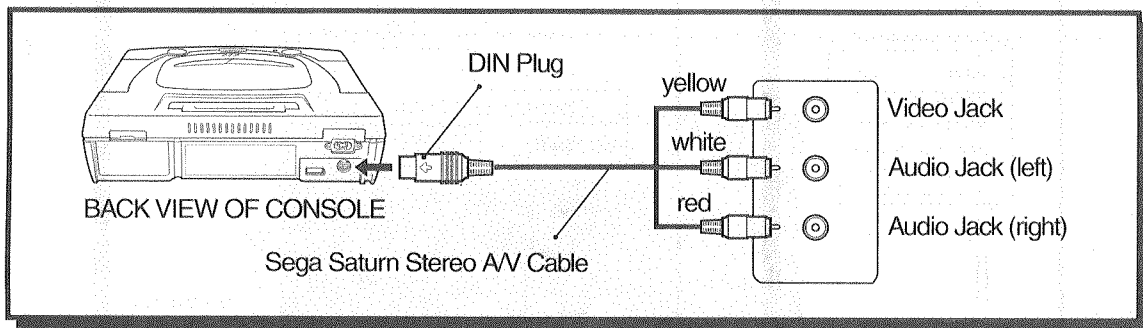

1. Connect the DIN plug to the A/V OUT jack on the back of the Sega Saturn unit, making sure that the arrow on the DIN plug faces upward.
2. Connect the yellow (video) jack into the Video Input jack of your TV or VCR.
3. Connect the audio jacks of the A/V Cable to your TV or VCR (the white jack into the left audio input and the red jack into the right audio input) as shown in the diagram above.
4. Switch to the A/V input* setting on your TV or VCR when using the Sega Saturn.

*Names for the A/V input setting vary with TV and VCR makers, for example Input, Video, Line In, Mode, Aux Channel 91, 92, 99 and 00. Consult your TV or VCR manual for more information on settings.

Connecting to TVs Without Audio/Video Jacks

TV or VCR with Single-plug Antenna Cable (for Cable TV or VHF Antenna)

If your TV or VCR uses a single-plug antenna or Cable TV cable, you need an RF Unit (MK 80106, sold separately).

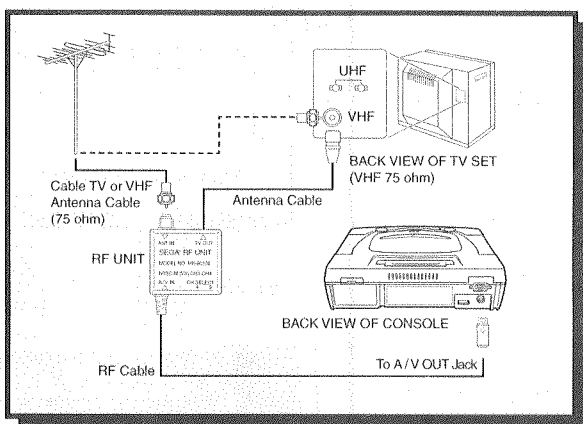
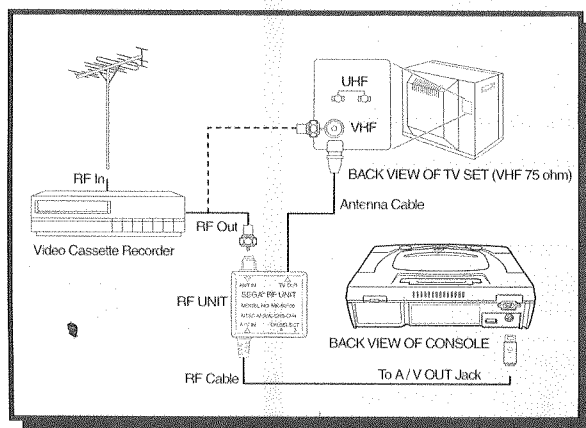

1. Connect the Cable TV/VHF Antenna cable (or VCR's RF Out plug) into the ANT IN port of the RF Unit.
2. Plug the RF Unit's antenna cable into the TV VHF input jack. If a twin-lead antenna wire is required, you'll need a matching transformer to make this connection (see page 11).
3. Plug the RF cable into the A/V OUT jack on the back of the Sega Saturn.

Notes

- If your VCR has audio and video jacks, connect the jacks as described in "Connecting to a TV or VCR with A/V Input."
- See page 7 for instructions on ordering Sega Saturn RF Units.

Cable Ready TV with F-type Converter

If your TV uses an F-type converter, you need an RF Unit (MK-80106, sold separately).

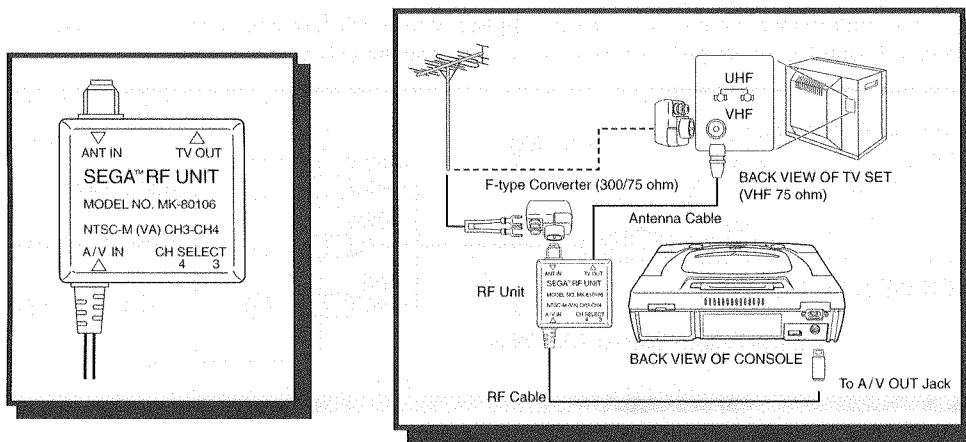

1. Locate the F-type converter, unplug it from the TV, and connect it to the ANT IN port of the RF Unit.
2. Plug the RF Unit antenna cable into the TV VHF input jack as shown in the diagram above.
3. Plug the RF cable into the A/V OUT jack on the back of the Sega Saturn.

TV with an Antenna Cable and Twin-Lead Antenna Wire

If your TV uses a twin-lead antenna wire, you'll need a matching transformer and an F-type converter (both available from electronics stores) and an RF Unit (MK-80106, sold separately).

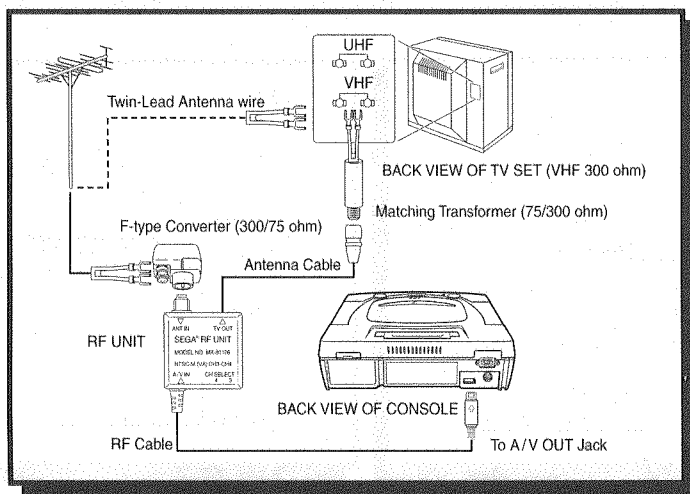

1. Disconnect the twin-lead antenna wire from the TV, and connect it to the F-type converter.
2. Plug the F-type converter into the ANT IN port of the RF Unit.
3. Plug the RF Unit's antenna cable into the matching transformer, and connect the transformer's twin-lead antenna wire to the TV VHF input as shown in the diagram above.
4. Plug the RF cable into the A/V OUT jack on the back of the Sega Saturn.

Note: See page 7 for instructions on ordering Sega Saturn RF Units.

TV with Cable TV or VHF Antenna Cable and Matching Transformer

If a cable TV or a VHF antenna cable is already plugged into a matching transformer, you need an RF Unit (MK-80106, sold separately).

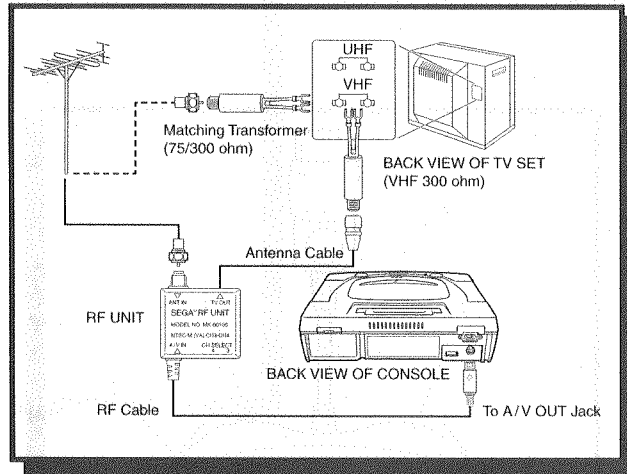

1. Leave the twin-lead antenna wire of the matching transformer connected to the TV. Unplug the VHF antenna cable from the other end of the transformer.
2. Plug the VHF antenna cable into the ANT IN port of the RF Unit.
3. Plug the RF Unit antenna cable into the matching transformer.
4. Plug the RF cable into the A/V OUT jack on the back of the Sega Saturn.

Setting the TV Channel

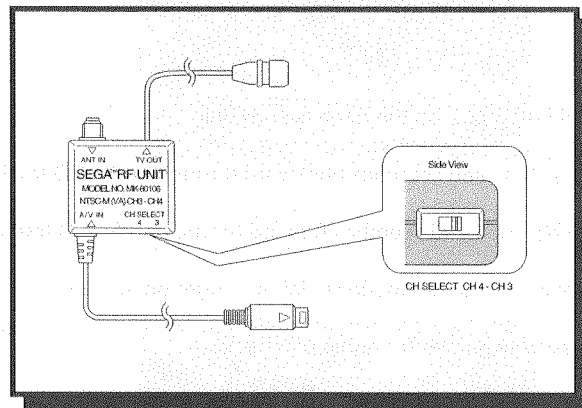

1. If you are using the RF unit, set the channel switch on the RF unit to CH3.
2. Set your TV to channel 3.
3. If channel 3 is used for TV viewing, set your TV to channel 4. Then set the channel switch on the RF unit to CH 4.

Note: If your TV has an automatic fine-tuning control (AFC), turn it off and manually adjust the picture. However, if you have a color TV that turns black and white when the AFC is turned off, leave the AFC on.

THE SEGA SATURN CONTROL PAD

The Sega Saturn Control Pad controls gameplay when using Sega Saturn game CDs, and controls other functions when playing audio CDs.

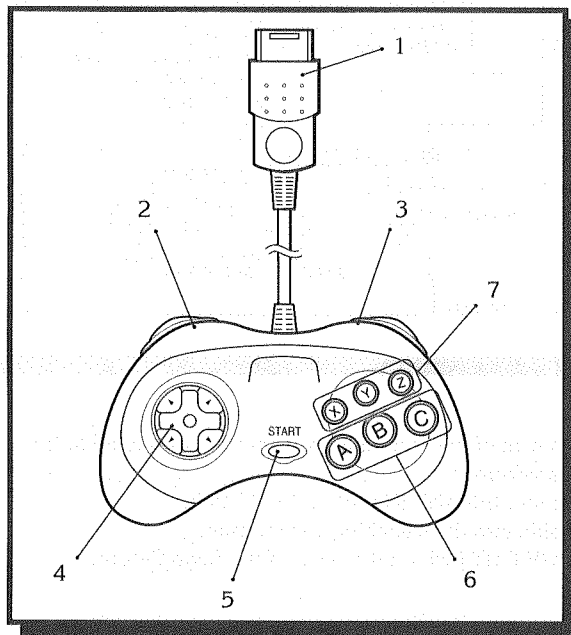

Button Controls

1. Connect the **Controller** to Control Port 1 or 2 on the Sega Saturn unit.
2. The **Left Shift Button (Button L)** skips and searches backward through audio CD tracks.
3. The **Right Shift Button (Button R)** skips and searches forward through audio CD tracks.
4. The **Directional Pad (D-Pad)** moves the cursor up, down, left and right on screen.
5. The **Start Button (Start)** starts/pauses games (or audio playback).
6. **Buttons A and C** make selections, and **Button B** cancels selections.
7. **Button X** cycles through audio playback repeat options. **Button Y** stops audio playback. **Button Z** pauses and resumes audio playback.

Notes

- Remember to turn the power to the Sega Saturn off before connecting the Control Pad, otherwise the Control Pad may not respond.
- Plug the Control Pad into Control Port 1.
- For two-player games, a second Control Pad (sold separately) is required.
- For information on the button functions for a game, check the game's instruction manual.

EASY START!

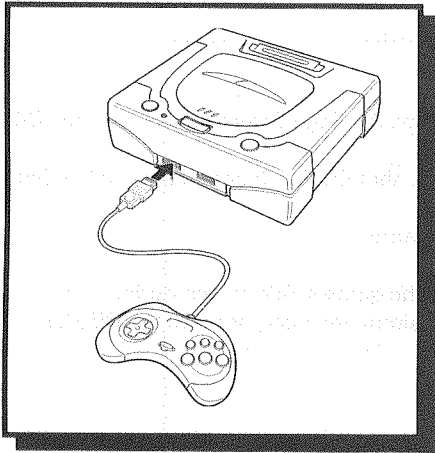

Connecting the Control Pad

When using one Sega Saturn Control Pad, plug it into Control Port 1. If you are using a second Control Pad (MK-80116, MK-80100, sold separately), plug it into Control Port 2. Always plug in the Control Pads before switching on the power to the Sega Saturn unit, otherwise the Control Pad(s) may not respond.

INITIAL SETTINGS

When you switch on the Sega Saturn for the first time, or after you change the lithium battery, the Set Language screen appears, followed by the Set Clock screen.

Set Language



You can choose to view Sega Saturn screen messages in English, German, French, Spanish, Italian or Japanese. Press the D-Pad to highlight a language and press Button A or C to select. The Set Clock screen appears next.

Set Clock

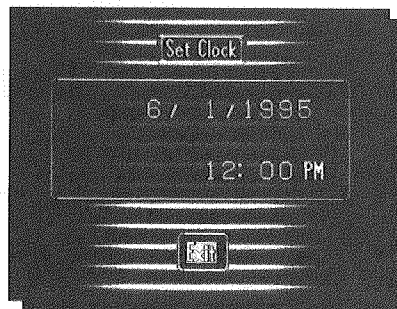

Press the D-Pad left or right to move between DATE and TIME, and press up or down to change the numbers. When you're finished, Select EXIT and press Button A or C to input the new settings. The next screen that appears is the Audio CD Control screen.

Playing Sega Saturn CD Games

Starting a Session

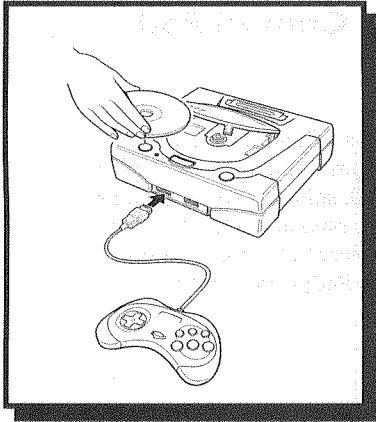

1. Press the **OPEN** button on the Sega Saturn unit to open the CD door.
2. Insert the CD (label up!), shut the CD door and turn on the Sega Saturn.
3. Press Start to start the game.
4. If you want to return to the game's Title screen during play, press Buttons A, B and C and START simultaneously, or press the **RESET** button.

Ending a Session

1. Press the **RESET** button while holding down Button A.
2. Press the **OPEN** button to open the CD door and take out the CD.

Note: Before you remove the CD, check that the CD Control screen appears (which means the CD has stopped spinning and is safe to remove from the Sega Saturn).

3. Switch off the **POWER** button on the Sega Saturn unit.

Playing Audio CDs

Your Sega Saturn can play various types of audio CDs including CD+G, CD+EG and audio tracks on CD-ROMs intended for other platforms. (For more on Audio CDs, see page 20.)

Starting a Session

1. Insert the CD (label up!), Shut the CD door and turn on the Sega Saturn. In a few seconds, the Audio CD Control screen appears.
2. Press START or Button Z, or highlight Play/Pause on screen and press Button A or C to start the CD.

Ending a Session

1. Highlight Stop on the Audio CD Control screen and press Button A or C, or if the Audio CD Control screen is not displayed, press the **RESET** button.
2. Press the **OPEN** button to open the CD door and take out the CD.

Note: Before you remove the CD, wait a few moments to make sure the CD has stopped spinning and is safe to remove from the Sega Saturn.

3. Switch off the **POWER** button on the Sega Saturn unit.

CONTROL SCREENS AND BUTTON FUNCTIONS

The Audio CD Control screen is the main control panel for audio CDs and CD+G discs. Error messages and other information are displayed here, as well as various control functions.

The Audio CD Control Screen

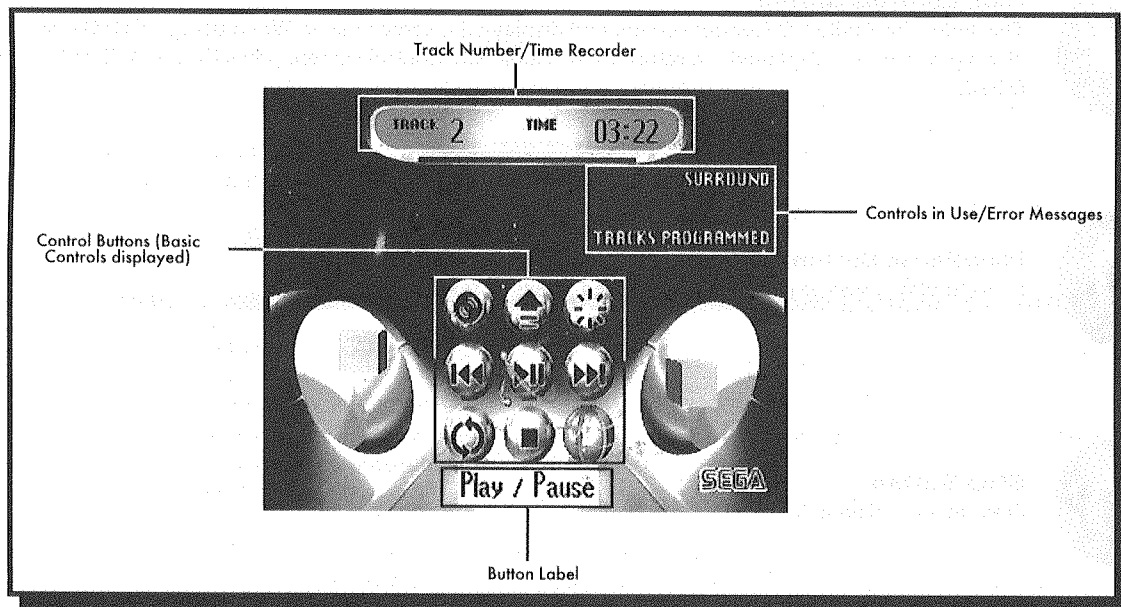

The way to access the Audio CD Control screen depends on the type of disc inserted.

When a CD other than a Sega Saturn CD is inserted:

If the power is off, press the **POWER** button; if the power is on, press the **RESET** button.

When a Sega Saturn CD is inserted:

If the power is off, press the **POWER** button while holding down Button A; if the power is on, press the **RESET** button while holding down Button A.

Basic Controls



Multi-Button

For Sega Saturn Game CDs, select this to start the game. For CD+G and CD+EG discs, press to open the Set CD+G Channel window.

Set CD+G Channel Window

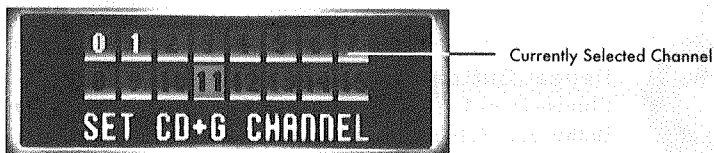

The channel function allows you to program up to 16 channels per disc.

1. Highlight the Multi-Button and press Button A or C to open the Set CD+G Channel.
2. Press the D-Pad to highlight a channel, and press Button A or C to select. Press Button B to reset the channels to the default.
3. When you're finished press Start to return to the Audio CD Control screen.



System Settings Button

Press to see the System Settings screen (see page 20). You can also use the System Settings Button to access the Memory Manager screen (see page 19).



Hide Controls Button

This hides the Audio CD Control screen, and displays the screen saver. When using a CD+G disc, the disc's graphics are displayed. To return to the Audio CD Control screen, press Button A, B or C or the D-Pad.



Play/Pause Button

Press to play, press to pause. When paused, press to resume play.

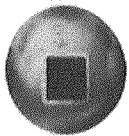

Stop Button

Press to stop playback.



Skip Forward Button

Press to skip a track. Press and hold to search through the current track.



Skip Backward Button

Press to jump back a track. Press and hold to scan backward through the current track.



Repeat Button

Choose from **1** (repeat one track), **All** (repeat all tracks) and **Off** (to cancel the Repeat function) Press Button A or C to select your choice.



Change Controls Button

This switches from Basic Controls to Advanced Controls.

Advanced Controls

Use the Advanced Controls to make various adjustments to your audio CD listening environment.

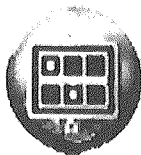

Program Sequence

Program a customized play list! Use the D-Pad to select a track from the upper list and press Button A or C to place the track in the lower list. Select the next track the same way. To delete selections (one by one), press Button B. When done, press Start. Press Button Z to start/pause program play.



Upper list shows tracks available on the disc.

Lower list shows tracks selected for playback.



Shuffle Tracks

This function arranges the audio tracks at random. Press Shuffle Tracks again to resume normal play order. (Shuffle Tracks cancels other programmed sets.)



Repeat A-B

This repeats a section of a track. Press once to determine the starting point and again to fix the end point. Press Repeat A-B again to return to normal play. (Repeat A-B cannot be used with Scan Intros.)



Scan Intros

Listen to the first 10 seconds from each track in the play list in order. To return to normal play, press Scan Intros again. (This function cannot be used with Repeat A-B.)



Adjust Surround

This simulates a three-dimensional audio effect. Use the D-Pad to increase or decrease the effect. Press Button B to reset to the default level. (Adjust Surround cannot be used with Adjust Pitch or Mute Vocals.) When done, press START to exit.

Note: Setting the Adjust Surround level too high may cause distortion in certain types of music. This is not a fault with your system. Set to a more suitable level.

Increase 3D audio effect →





Adjust Pitch

Set the pitch of audio playback tracks or mute vocals. Press the D-Pad left or right to adjust the pitch option. In the Pitch option, press the D-Pad left or right to raise or lower the pitch. Press Button A or C to mute the vocals, and press Button B to reset to the default (restoring the vocals). Adjust Pitch cannot be used with Adjust Surround. Press START to exit.

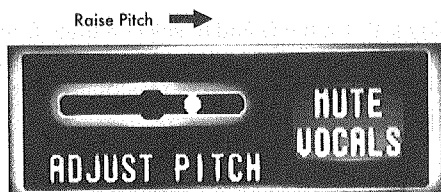

Note: Mute Vocals suppresses the central portion of the audio signal. For stereo recordings, a trace of the vocals will remain. Mute Vocals is not effective on mono recordings, and may not be effective for such genres as classical music, duets, choral music, various forms of ethnic music and recordings with such effects as echo.



Clear All Settings

Resets all Audio CD Control Panel settings to default. Press Button A or C to clear settings.



Change Screen

Select the time display format of your choice.

TRACK TIME ELAPSED tells you how much time has elapsed in the current track.
 TOTAL TIME ELAPSED tells you how much time has elapsed since the play list started.
 TRACK TIME REMAINING is the time left in the current track.
 TOTAL TIME REMAINING is time left until the end of the play list.



Change Controls Button

This switches from Advanced Controls to Basic Controls.

BACKUP FUNCTIONS AND SYSTEM SETTINGS

The Memory Manager Screen



Many games have a backup option which allows you to save game data to continue later. Consult the game manual on how to save games. The Sega Saturn also has an auto-save system backup memory that saves some data automatically. However, this only works if a lithium battery is inserted in the unit (see page 6). If the system power is off, press the **POWER** button while holding down Buttons L and R. If the power is on, press the **RESET** button while holding down Buttons L and R. In either case, the Systems Settings screen appears. Highlight Manage Memory and press Button A or C to open the Memory Manager screen.

Initializing

When you first use the Sega Saturn, the system backup memory initializes automatically. However, you can re-initialize at any time by clearing all data in the system backup memory.

1. Open the Memory Manager as described above.
2. Select CLEAR in the System Memory box and press Button A or C. When the Confirmation window appears, select YES and press Button A or C to erase the internal memory, or select NO to cancel.

Note: If the message NOT CLEARED! appears, there is a problem with your system backup memory. Consult your Sega dealer or call 1-800-SEE-SATURN for further assistance.

Erasing Data

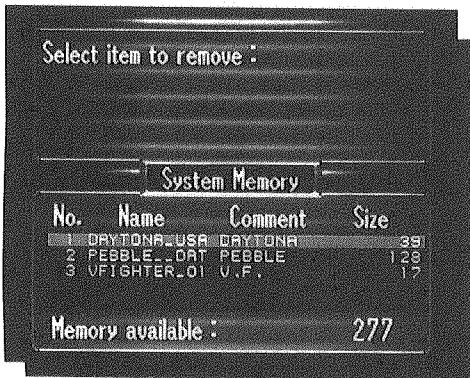

1. Open the Memory Manager screen.
2. Select REMOVE ITEM and press Button A or C to open the Delete screen.
3. Highlight the file you wish to delete and press Button A or C. The item's name and information appears at the top of the screen, along with a YES and NO confirmation. Select YES and press Button A or C to erase the item, or NO to cancel the erasure.
4. When you're done, press Button B to return to the Memory Manager screen.

Note: If the message NOT REMOVED! appears, there is a fault with your system backup memory. Consult your Sega dealer or call 1-800-SEE-SATURN for further assistance.

When you are finished initializing or erasing, select Exit at the Memory Manager screen and press Button A or C to return to the System Settings screen.

Caution

Do not switch off the power while initializing or deleting, or you may damage the data in your system backup memory and need to re-initialize. The **RESET** button is disabled during these operations.

SYSTEM SETTINGS

You can change the time, date, memory and language settings on your Sega Saturn at any time in the System Settings screen. To access these options, highlight System Settings in the Audio CD screen, and press Button A or C. Highlight an option and press Button A or C to access.

Select **Clock** to change the clock settings (see page 13).

Select **Memory Manager** to delete or copy data (see page 19).

Select **Language** to change the displayed language (see page 13).

Select **Other Settings** to change the following options:

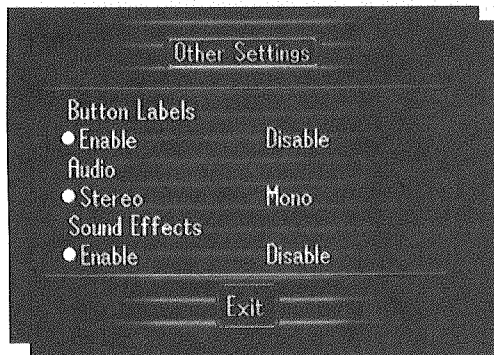

Button Labels

Choose whether or not to display button information on the Audio CD Control screen.

Audio Output:

Choose to have stereo or mono audio output when playing CDs and CD+G and CD+EG discs. (If you are using a Sega RF Unit, output will be mono regardless of setting.)

Sound Effects:

Choose to have sound effects on or off in the Audio CD Control screen.

ADVANCED CD FUNCTIONS

Your Sega Saturn can play various types of audio CDs. Although you cannot run applications on CD-ROMs intended for other platforms, you can play audio tracks from these discs.

Playing Standard Audio CDs

1. Insert the CD (label up!), shut the CD door and turn on the Sega Saturn. In a few seconds, the Audio CD Control screen appears.
2. Press Start or Button Z, or highlight Play/Pause on screen and press Button A or C to play the CD.
3. Select HIDE CONTROLS and press Button A or C to hide the Audio CD panel and display the Sega Saturn screen saver. (Press Button A, B, or C or the D-Pad at any time to access the Audio CD panel).

Playing Sega Saturn CDs

You can listen to your Sega Saturn CD game sound tracks. If the power is off, press the **POWER** button while holding down Button A. If the power is on, press the **RESET** button while holding down Button A.

Playing CD+G and CD+EG Discs

A **CD+G** is a music and graphics CD, and **CD+EG** is the next generation of CD, featuring extended graphics with up to 256 colors! Both types of discs can be played on Sega Saturn.

1. Insert the CD (label up!), shut the CD door and turn on the Sega Saturn. In a few seconds, the Audio CD Control screen appears.
2. Press Start or Button Z, or select Play/Pause on screen and press Button A or C. In a few seconds, the track number and time appear, and music and graphics begin.
3. Select HIDE CONTROLS and press Button A or C to hide the Audio CD panel and display the Sega Saturn screen saver. (Press Button A, B, or C or the D-Pad at any time to access the Audio CD panel).

TROUBLESHOOTING

ERROR MESSAGES

DISC UNSUITABLE FOR THIS SYSTEM	<ul style="list-style-type: none"> • Is the type of CD suitable for your Sega Saturn? • Is the surface of the CD dirty?
GAME DISC UNSUITABLE FOR THIS SYSTEM	<ul style="list-style-type: none"> • Is the type of CD suitable for your Sega Saturn?
DRIVE EMPTY	<ul style="list-style-type: none"> • Is a disc inserted properly in the Sega Saturn? • Is the disc badly damaged? • Is the disc dirty? • Is the disc label side up? • Is the type of CD suitable for your Sega Saturn?
DISC REQUIRES SYSTEM APPLICATION	<ul style="list-style-type: none"> • Do you have the additional hardware or software required to play the disc?

OTHER PROBLEMS

No picture or sound

- Is the TV securely connected to the power source?
- Is the power to the TV switched on?
- Is the TV set to Audio/Video mode?
- Is the Power Cord securely and correctly connected?
- Is the Sega Saturn **POWER** button switched on?
- Is the RF unit set to the correct channel?
- Is the Stereo A/V Cable securely connected?
- Check the pins on the A/V jack. You need to use a 3-pin plug.

Sega Saturn CD game will not start

- Is the disc the right way up?
- Is the disc clean and free from damage?

The color does not look right

- Are the TV color controls set properly?

Sound is mono but should be stereo

- Is the audio output set to mono?
- Are the audio sockets properly connected to the TV?

The date and time revert to default settings

- Is the lithium battery running low?
- Have you removed the insulation sheet from the lithium battery?

Cannot save

- Is the lithium battery running low?
- Have you removed the insulation sheet from the lithium battery?

The screen is blue or black

- Is the Stereo A/V Cable connected properly?

If other problems arise, first try pressing the Reset button or switching the Power button on and off. If this does not work, unplug the Power Cord from the power supply. Next, try reconnecting the Sega Saturn, following the instructions in this manual. Finally, follow the instructions for resetting the Sega Saturn described below. If the problem persists, consult your Sega dealer, or call 1-800-SEE-SATRUM.

RESETTING THE SEGA SATURN

If the Reset button fails to function, or the CD Audio Control screen fails to appear after following the operating instructions in this manual, follow the instructions below to reset the Sega Saturn unit. *Note that all internal settings revert to the default, and all internal memory data is erased.*

1. Switch off the power to the Sega Saturn and unplug the Power Cable from the outlet.
2. Remove the Battery Cover and remove the lithium battery.
3. After waiting for one minute, replace the lithium battery, replace the Battery Cover plug in the Power Cord and turn on the power to the Sega Saturn unit.

SEGA SATURN HARDWARE INFORMATION

Model Number:

MK-8000A

Power Source:

AC120 volts; 60Hz

Power Consumption:

25W

Operating Conditions:

Temperature 41°F to 95°F

Humidity 10% to 80% RH

Dimensions:

Width 260 mm (10.2 inches)

Length 230 mm (9.0 inches)

Height 83 mm (3.2 inches)

Specifications

Processors (8)

- Two Hitachi SH2 32-bit RISC @ 28.6MHz. 50 MIPS
- One Hitachi SH1 32-bit RISC
- VDP 1 32-bit video display processor
- VDP 2 32-bit video display processor
- Saturn Control Unit (SCU)
- Motorola 68EC000 sound processor
- Yamaha FH1 DSP sound processor

Memory

- 2 Megabytes (16 megabits) RAM
- 1.54 Megabytes (12 megabits) VRAM (Video RAM)
- 540 Kilobytes (4 megabits) Audio RAM
- 540 Kilobytes (4 megabits) CD ROM Cache

Video

- VDP 1 32-bit video display processor
 - sprite, polygon and geometry engine
 - dual 256KB frame buffers for rotation and scaling effects
 - Texture Mapping
 - Goraud Shading
 - 512KB cache for textures
- VDP 2 32-bit background and scroll plane video display processor
 - background engine
 - 5 simultaneous scrolling backgrounds
 - 2 simultaneous rotating playfields
- 200,000 Texture Mapped Polygons/Second
- 500,000 Flat Shaded Polygons/Second
- up to 60 frames per second animation
- 24-bit true color graphics
- 16.7 million available colors
- 320x224, 640x224 and 720x576 resolution

Audio

- Yamaha FH1 24-bit Digital Signal Processor @ 22.6MHz
- Motorola 68EC000 sound processor @ 11.3MHz
- 32 PCM (Pulse Code Modulation) Channels
- 8 FM (Frequency Modulation) Channels
- 44.1 KHz Sampling Rate.

Storage

- CD ROM (2x)
- 320 Kilobytes/Second Transfer Speed
- Audio CD Compatible
- CD+G Compatible
- CD+EG Compatible
- CD Single (8 cm CD) Compatible
- Optional - Video CD, Photo CD, EBook, Digital Karaoke
- Optional - 512 KB Memory Cartridges for game data saving

Input/Output

- High speed serial communications port
- Internal 32-bit Expansion port
- Internal Multi AV Port for Video CD (MPEG) adaptor
- Composite Video/Stereo (Standard)
- NTSC RF (Optional)
- S-Video Compatible (Optional)
- RGB Compatible (Optional)
- HDTV Compatible (Optional)
- Digital/Analog Controllers (x12 with 6Player Adaptor)

Note: Characteristics and specifications may be changed without notice.

LIMITED WARRANTY

Sega of America, Inc., warrants to the original consumer purchaser that the Sega Saturn System and all component parts shall be free from defects in material and workmanship for a period of ninety days from the date of purchase. If a defect covered by this limited warranty occurs during this 90 day warranty period, Sega will repair or replace the defective system or component part, at its option, free of charge.

This limited warranty does not apply if the Sega Saturn is used with products not licensed by Sega, or if the defects have been caused by negligence, accident, unreasonable use, modification, tampering or any other causes not related to defective materials or workmanship. Additionally, this warranty shall not be valid if the serial number of the Sega Saturn System unit has been altered, defaced or removed in any way.

Please retain the original or a photocopy of your dated sales receipt to easily establish the date of service for in-warranty repairs. To receive warranty service, call the Sega Consumer Service Department at:

1-800-USA-SEGA or 1-800-SEE SATURN.

To receive Canadian warranty service, call the Sega of Canada Service Department at:

1-800-872-7342. PLEASE CALL FIRST FOR REPAIR INFORMATION. The cost of returning the system to Sega's Service Center shall be paid for by the purchaser.

DO NOT RETURN YOUR SEGA SATURN SYSTEM TO YOUR RETAIL SELLER.

REPAIRS AFTER EXPIRATION OF WARRANTY

If your Sega Saturn System requires repairs after the termination of the 90-day limited warranty period, you may contact the Sega Consumer Service Department at one of the numbers listed above. If the technician is unable to solve the problem by phone, he or she will advise you of the estimated cost of repair. If you elect to have the repair done, you will need to return the defective merchandise, freight prepaid and insured against loss or damage, to Sega's Service Center with an enclosed check or money order payable to Sega of America, Inc., for the amount of the cost estimate provided to you by the technician. If, after inspection, it is determined that your system cannot be repaired, it will be returned to you and your payment will be refunded.

LIMITATIONS ON WARRANTY

Any applicable implied warranties, including warranties of merchantability and fitness for a particular purpose, are hereby limited to ninety days from the date of purchase and are subject to the conditions set forth herein. In no event shall Sega of America, Inc., be liable for consequential or incidental damages resulting from the breach of any express or implied warranties.

The provisions of this limited warranty are valid in the United States only. Some states do not allow limitations on how long an implied warranty lasts, or exclusion of consequential or incidental damages, so the above limitation or exclusion may not apply to you. This warranty provides you with specific legal rights. You may have other rights which vary from state to state.



SEGA SATURN™