

The Future Is Now
SNK



NEO·GEO^{CD}
— Top-Loading Model —

Instruction Manual



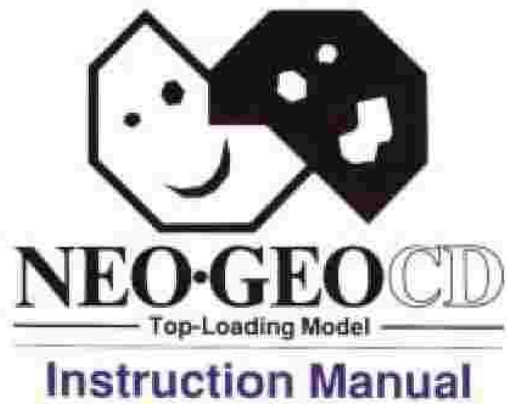

CONTENTS

■ BEFORE USING THE CONSOLE	p.2
■ NEO GEO CD PARTS:	
What They Are and What They Do	p.3-4
■ CONTROLLER PARTS:	
What They Are and What They Do	p.5
■ CONNECTING TO YOUR TELEVISION (1)	p.6
■ CONNECTING TO YOUR TELEVISION (2)	p.7
■ CONNECTING ATTACHMENTS	p.8
■ BEGINNING GAME PLAY	p.9-10
■ RESETTNG AND FINISHING GAMES	p.11-12
■ STORING GAME DATA	p.13-14
■ MUSIC FUNCTIONS (1) MUSIC PLAYBACK	p.15-16
■ MUSIC FUNCTIONS (2) NUMBER KEYS AND CANCEL KEY	p.17-18
■ MUSIC FUNCTIONS (3) SPECIAL COMMANDS (A)	p.19-20
■ MUSIC FUNCTIONS (4) SPECIAL COMMANDS (B)	p.21-22
■ NOTES ON USE	p.23-24
■ TROUBLESHOOTING	p.25
■ NEO GEO CD CONSOLE SPECIFICATIONS	p.26

Thank you for your purchase of the NEO GEO CD ROM. This instruction booklet is designed to instruct you on the proper use of the many functions and abilities of the console, so please read through this booklet thoroughly to fully understand your console.

●●THINGS TO DO FIRST

■ CONTENTS OF THE PACKAGE

Included in your NEO GEO CD package, you will find the following items. Please make sure these items are included in the quantity listed below.

① NEO GEO CD CONSOLE	1
② NEO GEO CD PAD CONTROLLER	2
③ AC/DC ADAPTOR	1
④ RF or AV or RGB Cable	1
⑤ INSTRUCTION BOOKLET	1

●●BEFORE USING THE CONSOLE

Your NEO GEO CD ROM is capable of storing game data within the internal back-up memory RAM for a period of two weeks. When using your console for the first time, be sure to format the back-up memory. An explanation of the formatting process is detailed on p.13-14 in the Storing Game Data section of this manual.

NEO GEO CD PARTS: What They Are and What They Do

●●NEO GEO CD CONSOLE (Front View)

Power Switch

After pushing the switch, the indicator will turn red. Depressing the button again will turn the light off and will turn off the power of your console.

* Under any circumstances, do not turn your console OFF while it is in the NOW LOADING stage. This may result in damage to the internal workings of the console.

Flap Cover

Open here to set NEO GEO CD software or music CDs of 8/12 cm.

* NEVER open the cover while playing game or playing back music.

⋮⋮⋮ Mark

To open the flap cover, gently press on the ⋮⋮⋮ mark. Also push here to lock the cover.

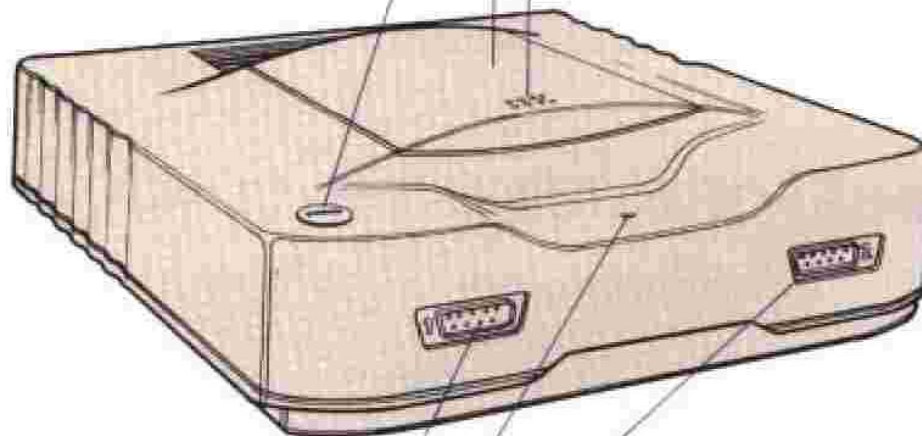

Controller Terminal 1 (Player 1)

Connect NEO GEO Controllers to this terminal.

Controller Terminal 2 (Player 2)

Connect the second NEO GEO Controller in this terminal for two-player game play.

Power Indicator

While the power is on, the indicator illuminates.

●●NEO GEO CD CONSOLE (Rear View)

AV Output Terminal (A/V OUT)

With the appropriate NEO GEO cord, connect your console to your television.

AV Output Terminal (VIDEO OUT)

Connect the yellow projection cord here.

Adaptor Terminal (DC IN)

Connect the adaptor here.

* Do not use any other adaptor than the customized NEO GEO AC/DC Adaptor.

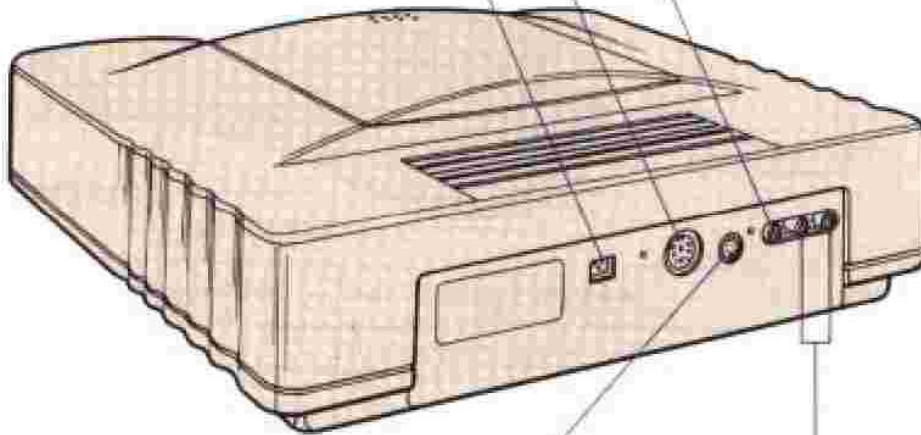

S-Terminal Video Output (S-VIDEO OUT)

Connect an S-terminal cord (sold separately) here.

Stereo Sound Output Terminal (AUDIO OUT)

Connect the Audio cord to this terminal. Match colored plugs to the proper R terminal (red) and L terminal (white) on your stereo.



CONTROLLER PARTS: What They Are and What They Do

●●CONTROLLER

Used for manipulating the control screen and game play. Note that the use of the joystick and buttons varies with each software title.

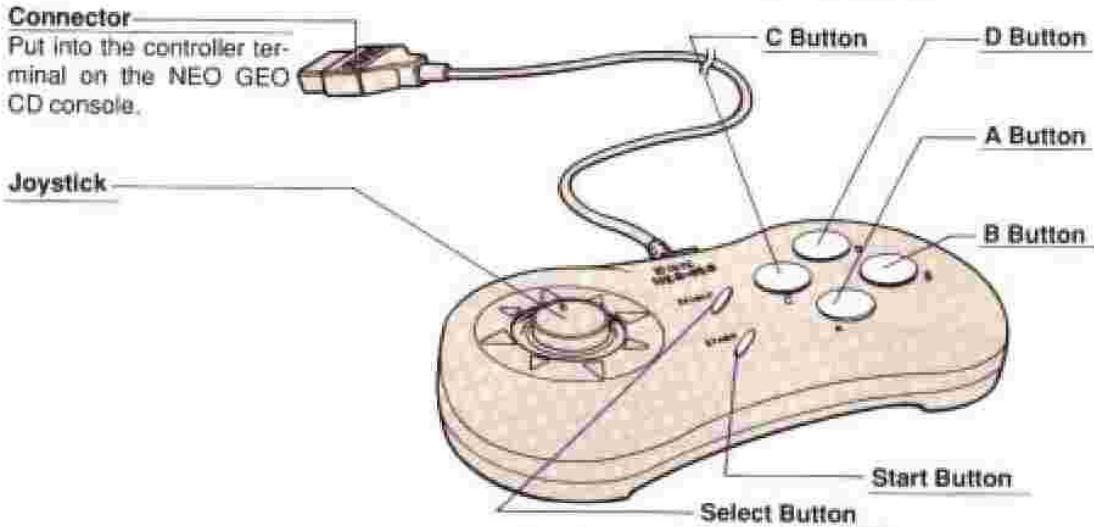
* The use of the controller is explained in the Instruction Booklet for each software title.

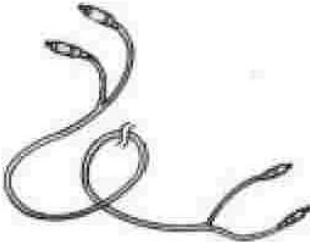

<p>●●AC Adaptor</p> <p>Supplies power to the console from power source. * Do not use any other adaptor than the customized NEO GEO AC/DC ADAPTOR.</p> 	<p>●●Audio Connector Cord</p> <p>For stereo televisions or audio appliances it connects the NEO GEO CD to a variety of sound producing sources (i.e., stereos, televisions, amplifiers, etc.)</p> 	<p>●●Projection Connector Cord</p> <p>Connects the console to the Projection connector of television sets.</p> 
--	--	---

* For a detailed explanation of connection methods, refer to the Television Connection sections on p.6-7 or the Controller/AC adaptor methods in the Connecting Attachments section on p.8.

CONNECTING TO YOUR TELEVISION (1)

To connect the console to a television, there are 5 methods listed below as A to E. These methods are based on various types of televisions. Read each section carefully to see which section applies best to your television set.

NOTE: When connecting the console to your television, always make sure that the power switch is off on both. Further, when connecting the console with the television, do not use a variety of methods at one time. Please use only one of the methods specified below.

A CONNECTING TO A/V TERMINALS

NEO GEO CD ROM (rear view)

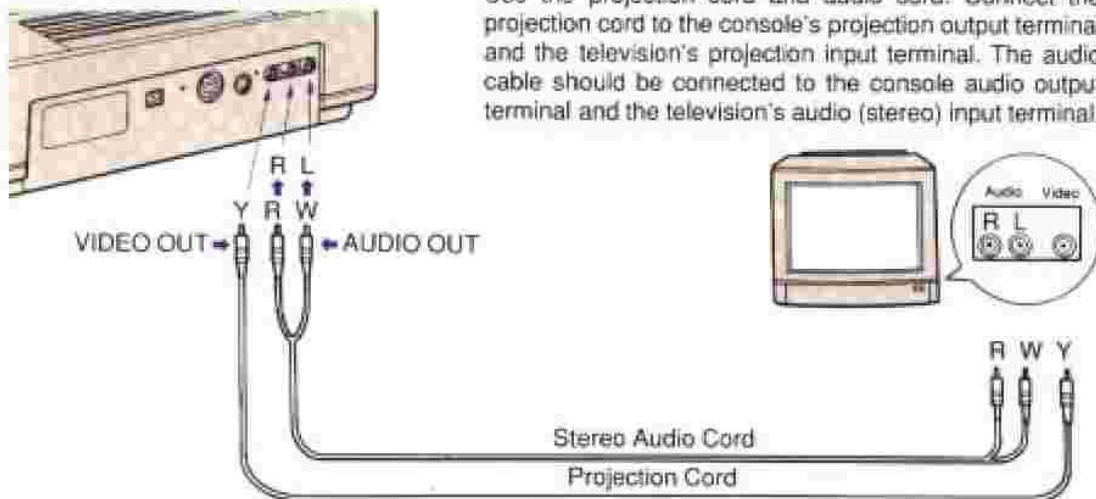

B CONNECTING TO A MONAURAL TELEVISION

NEO GEO CD ROM (rear view)



CONNECTING TO YOUR TELEVISION (2)

C CONNECTING WITH THE S-TERMINAL

NEO GEO CD ROM (rear view)

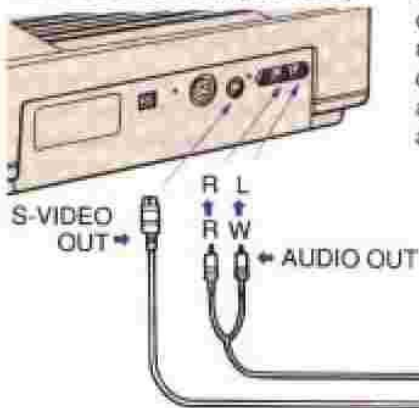

Use the S-Terminal and Audio Cord. Connect the S-Terminal cord (sold separately) to the console's S-Terminal output terminal and the television's S-picture input terminal. For sound, connect the console's audio output terminal to the television's audio input terminal with the audio cord.

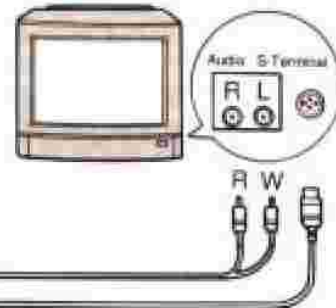

D CONNECTING TO THE 21-PIN RGB TERMINAL

NEO GEO CD ROM (rear view)

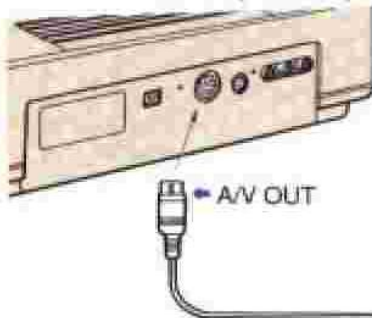

Using the NEO GEO RGB cable (FCG-9), connect the console's A/V output terminal to the television's 21-pin input terminal.

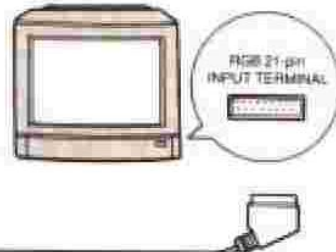

E CONNECTING TO THE TV ANTENNA TERMINAL

NEO GEO CD ROM (rear view)

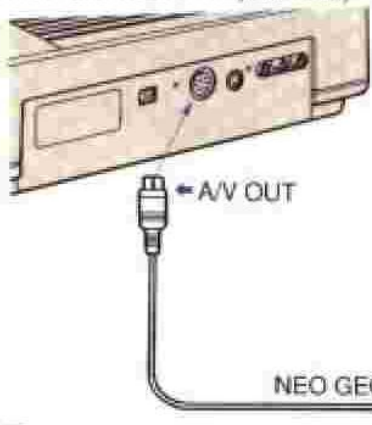

Using the NEO GEO RF-Converter (FCG-8), connect the console's A/V output terminal to the television's input terminal and antenna as shown below.

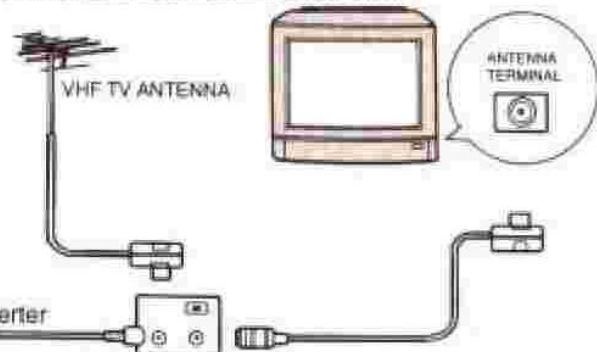

CONNECTING ATTACHMENTS

●●CONNECTING THE CONTROLLERS TO THE NEO GEO CD CONSOLE

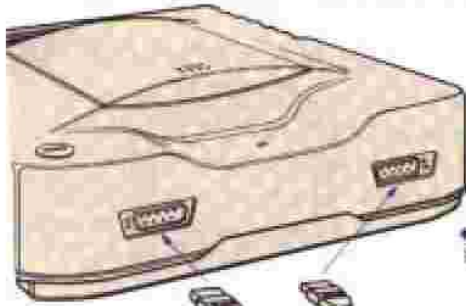

For 1-player play, connect the controller plug into controller terminal 1. For 2-player play, plug the second controller into controller terminal 2.

NOTE: Make sure the NEO GEO mark on the controller plug is facing up and place it straight into the connector.

→ Controller Terminal 2
Used to connect Controller 2.

Controller →
Terminal 1
Used for Controller 1. The Controller Terminal 1 must be in use to achieve 2-player play.

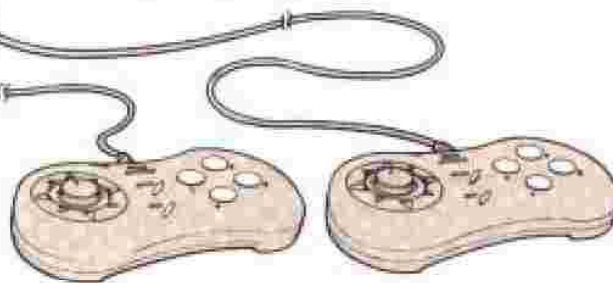

●●CONNECTING THE NEO GEO CD ROM AND AC ADAPTOR

NEO GEO CD ROM (rear view)



After connecting the controllers to the console, now you are ready to connect the AC Adaptor. Put the Adaptor plug into the indicated terminal of the console then plug it firmly into power outlet.

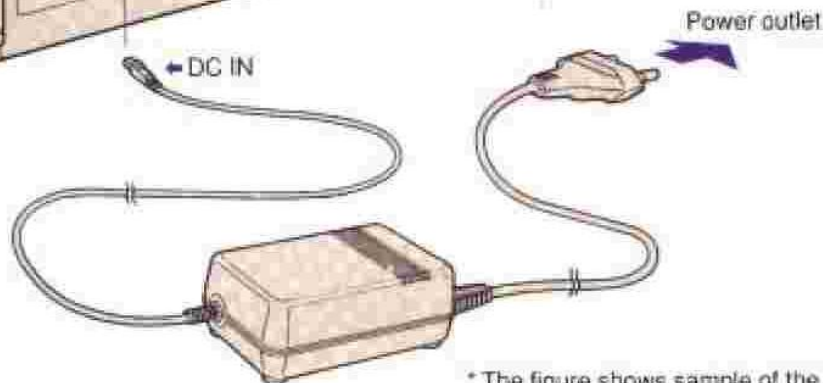

* The figure shows sample of the 2 pin plug.

BEGINNING GAME PLAY

● BEGINNING GAME PLAY

1 READINGY YOUR TELEVISION SET.

- 1 Turn on the television.
 - 2 Set the volume of your television and amp to their lowest settings.
 - 3 Adjust your television's screen input to console requirements.
- * When using the RF Converter (FCG-8), set your television to channel 1 or 2, as set on the RF-Switch.



Turn everything on!!!

2 OPERATING THE NEO GEO CD ROM (MAIN MENU SCREEN)

- 1 Place the adapter into the power outlet.
(Note: Make sure the outlet operates at 100–240 V 50/60 Hz)
 - 2 Turn the power switch to the console ON.
 - 3 At first, the NEO GEO Logo screen will appear on your television then change automatically to the MAIN MENU SCREEN. All functions can be chosen by the controller and carried out using this screen.
- * Set the volume to the appropriate levels when playing games or listening to your favorite music CDs.



3 SETTING DISCS

- 1 Softly press on the [⏏] mark on the flap cover to open the cover.
- 2 Place the disc gently with the print-side up.
- 3 Close the cover and press down the [⏏] mark to lock.

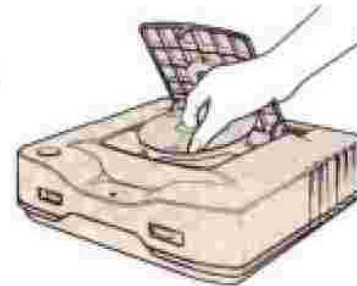

4 CD-ROM LOADING TIME

- 1 When the PUSH START BUTTON message appears at the bottom of the screen, push the START button on the 1-Player controller to begin the loading of game data.
- 2 When the loading of data is completed, the NOW LOADING message will disappear and the game title screen will appear. At this time, either push the START button or select the GAME START message displayed on the screen with the cursor, and press the A button.

* For further instructions, consult the Instruction Booklet of software.

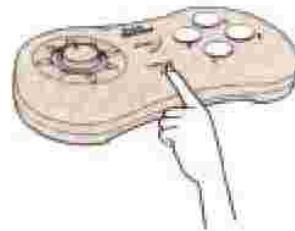

●●MAIN MENU SCREEN AT THE TIME OF GAME PLAY—



Hand Mark:

Commands the Select Cursor. Move this cursor with the joystick to select the desired command. Push the A button to carry out the command.

MEMORY: Back-Up Memory Function

Conducts the initializing of the back-up memory, display of a particular file name, and the elimination of game data. (For a more detailed explanation, see p.13-14 in the STORAGE OF GAME DATA section.)

PUSH START BUTTON Display:

Set the disc into the appropriate groove. When the display appears, press the START button on the Player-1 controller. The CD ROM will begin to load the game data.

RESETTING AND FINISHING GAMES

● TO RESTART THE GAME FROM THE BEGINNING... —

1 RETURN TO THE MAIN MENU SCREEN.

- Push the A, B, C and SELECT buttons down simultaneously and the screen will shift to the MAIN MENU SCREEN.
 - * The above method can be used on every screen except for the NOW LOADING SCREEN when data is being loaded into memory.

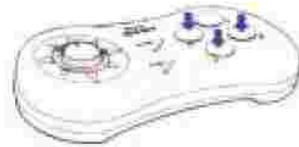

2 RESTARTING THE GAME

- To restart the game, either press the START button on the controller or select GAME START from the MAIN MENU SCREEN.

● REMOVING THE DISC DURING GAME PLAY —

1 RETURNING TO THE MAIN MENU SCREEN.

- Pressing the A, B, C and START button simultaneously will return you to the MAIN MENU SCREEN.
 - * This procedure can be carried out on all screens except during the NOW LOADING SCREEN when data is being stored into memory.
- Before opening the flap cover, wait for the disc to completely stop turning for about 10 seconds after MAIN MENU SCREEN appears. If it is opened earlier, it may result in trouble and/or damage.



2 OPENING THE FLAP COVER

- Gently press on the [:::] mark to open the flap cover.

3 REMOVING THE CD

- Without touching the bottom of the CD, gently remove the disc and put it in its protective case.

4 CLOSING THE FLAP COVER

- Close the flap cover and press down the [:::] mark to lock.
 - * Always make sure that the CD is set rightly.

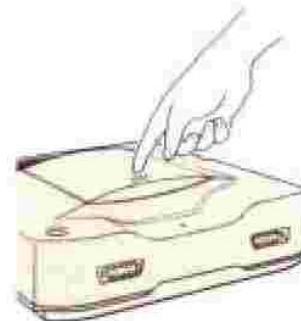

●●ENDING PLAY ON THE CD ROM PLAYER

1 RETURNING TO THE MAIN MENU SCREEN

- Push the A, B, C and START Button simultaneously on either the 1-Player or 2-Player controller to return to the MAIN MENU SCREEN.
 - * This procedure can be performed on all screens except for the NOW LOADING SCREEN when data is being loaded into memory.
- Before opening the flap cover, wait for the disc to completely stop turning for about 10 seconds after MAIN MENU SCREEN appears.

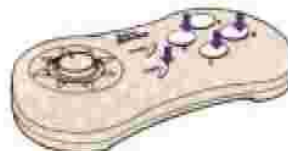

2 OPENING THE FLAP COVER

- Gently press on the [:::] mark to open the flap cover.

3 REMOVING THE DISC

- Be sure not to touch the bottom of the CD and gently remove it from the tray.

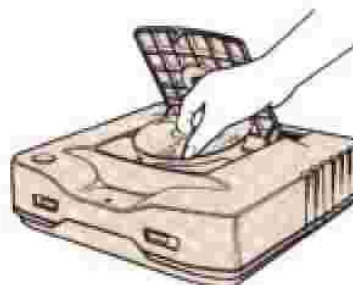

4 CLOSING THE FLAP COVER

- Close the flap cover and press down the [:::] mark to lock.

5 DECREASE THE VOLUME OF YOUR TELEVISION OR AMPLIFIER

6 TURN OFF THE POWER SWITCH OF THE NEO GEO CD CONSOLE

- Depress the power switch of the console until the indicator light goes off. This means the console has been turned OFF.



7 REMOVE THE AC ADAPTOR FROM THE OUTLET

NOTE

- Always remove the adaptor from the outlet when the console is not in use.
- When opening and closing the flap cover of your console, always do so by pressing the part of [:::] marks. DO NOT force the cover open with your hands or a tool, for this may result in damage to the console.
- NEVER open the flap cover while playing game, playing back music or in the NOW LOADING stage. It may cause problem on your machine.
- Make sure that the MAIN MENU SCREEN appears on display when you open or close the flap cover, or when you turn the power OFF.

STORING GAME DATA

THE BACK-UP MEMORY FUNCTION

Even when the NEO GEO CD is turned OFF, game data may be stored in the internal back-up memory for a period of up to two weeks. If the console is not turned on during a two-week period all data will be cleared from the back-up memory. To preserve data, it is recommended that you turn your machine on, for 10 to 20 minutes for charge, at least once during this two-week period. Should data be cleared, the back-up memory must again be formatted to save subsequent data. For proper SAVE and LOAD procedures, refer to the instruction booklet for each software title.

USING THE BACK-UP MEMORY—FORMATTING

When first using the NEO GEO CD ROM, first format the Back-Up Memory before game play. If you forget to format before game play, you will be unable to save game data later on.

* When FORMATTING is applied to the NEO GEO CD with stored data, the data will be deleted.

●●FORMATTING THE BACK-UP MEMORY

- 1 Turn on the NEO GEO CD ROM.
- 2 When the MAIN MENU SCREEN appears, move the cursor to the MEMORY function with the joystick and press the A Button on the 1-Player controller.
- 3 When the BACK-UP MEMORY UTILITY appears, select the BACK UP MEMORY FORMAT function with the cursor (▶) and press the A Button.
- 4 Follow the instructions on the screen to conduct the formatting of the BACK-UP MEMORY.
* Depressing the B Button will return you to the BACK-UP MEMORY UTILITY.

Example of screen display with saved data

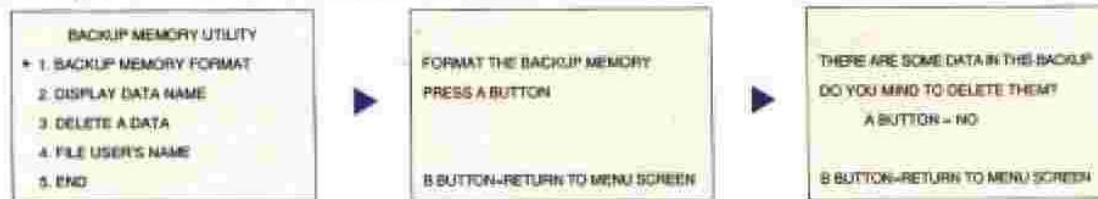

●●VIEWING STORED DATA

Stored game data is indicated by data file names on the screen.

- 1 By operating the same as in 1 and 2 of the BACK-UP MEMORY UTILITY procedure, match the cursor to the DISPLAY DATA NAME with the cursor (▶) and press A on the 1-Player controller.
- 2 In so doing, the DATA NAME will be displayed. Up to 6 separate files can be displayed on the screen at one time. To see files beyond this limit scroll up or down using the cursor to call up the next files.
* Pushing the B Button will return you to the BACK-UP MEMORY UTILITY.

●●DELETING STORED GAME DATA

There is a limit to the amount of data that can be stored in memory. When no more data can be stored within this memory, it will be necessary to delete unnecessary DATA NAME.

- 1 As in steps 1 and 2 of the BACK-UP MEMORY FORMAT procedure, call up the BACK-UP MEMORY UTILITY and select heading 3. Delete unnecessary DATA NAME with the cursor (▶) and push the A Button.
- 2 In so doing, DATA NAME will be displayed. Match the cursor (▶) to the data file you wish to delete and push the A Button.
- 3 The message DO YOU MIND TO DELETE THEM? appear. Reconfirm your choice to delete the data and push the A Button to delete unnecessary files.
* In steps 2 and 3, if data is not deleted, pushing the B Button will return you to the BACK-UP MEMORY UTILITY.

```
SELECT DATA TO BE DELETED
A BUTTON = DELETE
B BUTTON = RETURN TO MENU SCREEN
▶ PATAL FURY SPECIAL
SAMURAI SHODOWN
```

●●THE USER NAME RECORD

A user name of up to 15 characters can be recorded.

- 1 As in steps 1 and 2 of the BACK-UP MEMORY FORMAT, call up the BACK-UP MEMORY UTILITY and select 4. Select the USER'S NAME heading with the cursor (▶) using the 1-Player Joystick and press the A Button.
- 2 Because the USER'S NAME Screen will be displayed, select the desired characters with the joystick by moving the cursor (▶) and pressing the A Button. Once you have entered the name, record it by selecting END with the cursor and push the A Button.
* To cancel the procedure, push the B Button.

```
FILE USER'S NAME
|
A
A B C D E F G H I J K L M
N O P Q R S T U V W X Y Z
a b c d e f g h i j k l m
n o p q r s t u v w x y z
0 1 2 3 4 5 6 7 8 9 * -
! # $ % & ' : ; < = > ?
SPACE * ▶ END
B BUTTON = RETURN TO MENU SCREEN
```

●●COMPLETING THE BACK-UP FUNCTION

Select 5. END in the BACK-UP MEMORY SCREEN with the cursor (▶) and press the A Button. In so doing, after the NEO GEO logo mark appears, the MAIN MENU SCREEN will then appear.

```
BACKUP MEMORY UTILITY
1. BACKUP MEMORY FORMAT
2. DISPLAY DATA NAME
3. DELETE A DATA
4. FILE USER'S NAME
▶ 5. END
```

MUSIC FUNCTIONS (1) MUSIC PLAYBACK

Your NEO GEO CD ROM player, in addition to playing any music CD, can also play the game music recorded on the majority of game discs.

● BEGINNING MUSIC PLAYBACK

1 TURN ON THE NEO GEO CD CONSOLE

- ① After adjusting the volume of your television set, plug in the AC adapter to the outlet and press the POWER button of the NEO GEO CD ROM player console to turn it ON.
- ② After the NEO GEO display screen appears, the MAIN MENU SCREEN will appear.

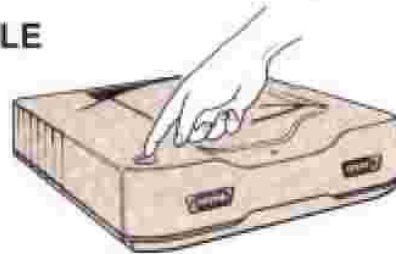

2 INSERTING CD DISCS

- ① Softly press on the [] mark on the flap cover to open the cover.
- ② Place the disc gently with the print-side up.
- ③ Close the cover and press down the [] mark to lock.
- ④ When inserting a CD, the console will conduct the disc check. On the MAIN MENU, under the TRACK heading, the number of tracks, playing time, and time remaining on the disc will be displayed.
* The diagram at the left shows a total number of 13 tracks and the playing time of the CD is 59' 49."



3 SELECTING PLAYBACK COMMANDS IN THE MAIN MENU SCREEN

- Basic Operation: Using the 1-Player controller, with the joystick, move the cursor to the desired command and push the A Button.
* With NEO GEO CD software, the tracks within the game program are not able to be selected. With normal playback, play will start automatically from the second track, the first track being made up of game data.



●●EXPLANATION OF PLAYBACK ON THE MAIN MENU SCREEN

BASIC PLAYBACK COMMANDS (USED IN NORMAL PLAYBACK)



- ▶ **PLAY:** Begins standard playback.
- || **Pause:** Temporarily stops playback. Pressing this a second time will resume playback.
- **Stop:** Stops playback.
- ▶▶ **Autosearch Forward:** Pressing this once will allow you to select the next track.
- ◀◀ **Autosearch Reverse:** Pressing this once will return to the beginning of a particular track. Pressing this twice will bring you to the beginning of the previous track.
- ▶▶ **Fast Forward:** Lets you search for music ahead of the current selection.
- ◀◀ **Fast Backward:** Lets you search for a particular passage previously played.

SPECIAL PLAYBACK COMMANDS



- TIME:** Allows the viewing of track times, elapsed time, and remaining time on a particular track or CD.
 - INTRO:** Scans the first seconds of each track automatically.
 - PROGRAM:** Allows you to select the order of tracks.
 - RANDOM:** Automatically scrambles the order of CD tracks and conducts playback.
 - REPEAT 1:** Repeats 1 track only for as many times as desired.
 - REPEAT ALL:** Repeats an entire disk.
 - A/B REPEAT:** Repeats a selected interval of music.
 - CANCEL:** Cancels all previously chosen functions.
 - 1-10 Number Keys:** Used to select track numbers.
- * For more detailed explanations of Special Playback Functions, see p.19-22.
 * During Special Playback Functions, Autosearch cannot be conducted.

EXPLANATION OF THE SCREEN DISPLAY

TRACK NUMBER DISPLAY:
Shows the track currently in play or being paused.

PLAY/PAUSE DISPLAY:
Shows (▶) for PLAY mode or (||) for PAUSE mode.

PLAYBACK TIME MODE:
Consists of 4 Separate Modes.

ELAPSED: Shows elapsed time of a particular track.

T. ELAPSED: Shows the elapsed time on a disc.

REMAIN: Shows the time remaining for a particular track.

T. REMAIN: Shows the time remaining on a disc.



INDEX: Shows the number of programmed tracks at PROGRAM function.
* The display will normally be (---).

LEVEL METER: Indicates the volume of the L and R channels.

INTRO: Shows the number of seconds played for the INTRO function.

FUNCTION DISPLAY: Indicates the function currently in use.

TRACK: Shows the number of tracks on a given disc.
* A maximum of 20 tracks is displayed at a time.

MUSIC FUNCTIONS (2) NUMBER KEYS AND CANCEL KEY

●●DIRECT SELECTION OF TRACKS USING THE NUMBER KEYS

DIRECT SELECTION OF UP TO 9 TRACKS

- 1 Match the cursor to the number key of the track you wish to hear and push the A Button on the 1-Player controller.

1 2 3 4 5 6 7 8 9 0 +10

- 2 The selected number will appear in the TRACK space and that track will begin to play.

DIRECT SELECTION OF TRACKS OVER 10

Example: Choosing track 10.

- 1 Match the cursor to the +10 symbol and push the A Button. The Track display will show "1-". (Until another number is selected, the Track display will continue to show this.)
 - To choose selections numbered above 20, while depressing the +10 symbol, the display will show "0-" to "(The maximum being multiple of 10)-" and repeat display. For example, in the case of a 40 track CD, depressing the +10 symbol with the cursor will display "1-", "2-", "3-", "4-", "0-", "1-"... in progression.
- 2 From the NUMBER KEYS, choose the 0 symbol and press the A Button. The track display will show "10" and automatically play track 10.
- For track 11, select the +10 symbol and 1 of the NUMBER KEYS; for track 12, press the +10 symbol and 2 of the NUMBER KEYS.

TRACK	INDEX
1-	--



TRACK	INDEX
10	--

CORRECTING MISTAKES MADE WITH THE NUMBER KEYS

Example 1: If the track number is 13 and the +10 symbol is activated more than once.

- 1 If, for example, one wishes to choose track 13, first activate the +10 symbol and press the A Button. The display will then show a "1-" under the track display.
- 2 Then, if the +10 symbol is activated on the second time, the track display will show "0-".
- 3 To return the track display to "1-", activate the +10 symbol a third time. In so doing, the "1-" display will appear.
- 4 To continue, choose one of the NUMBER KEYS with the cursor. For example, to select track 13, you would choose the 3 symbol, and play will begin.

TRACK	INDEX
1-	--



TRACK	INDEX
0-	--



TRACK	INDEX
1-	--



TRACK	INDEX
13	--

CORRECTING MISTAKES MADE WITH THE NUMBER KEYS

Example 2: Setting the track number above 14 when there are only 13 tracks available on the CD.

- 1 First, select the +10 key and press the A button. The track display will show "1-".
- 2 To continue, enter the second digit, selecting 4 to 9. In the case where there are only 13 tracks, the track number will not be accepted, and, consequently, the track display will show "1-" until a suitable track number is entered.
- 3 This time, choose one of the symbols 0-3, inside the 13 track limit, and the desired track will begin to play.

TRACK	INDEX
1-	--



TRACK	INDEX
1-	--



TRACK	INDEX
13	--

● THE CANCEL KEY

Use the CANCEL KEY in the Two Methods Shown Below.

1 TO CANCEL THE TRACK SETTING IN DIRECT TRACK SELECTION

To cancel a direct track setting, press the cancel key.

* To change the selected track, use the NUMBER KEY and select the desired track.

2 TO CANCEL A PROGRAM SETTING

When pressing the CANCEL KEY once, the track will display the previously selected setting.

* If the track is not corrected with the NUMBER KEYS, the track will remain programmed.

MUSIC FUNCTIONS (3) SPECIAL COMMANDS (A)

● PROGRAM PLAYBACK

For the PROGRAM function, you can place the tracks you want to listen to in the order you wish to hear them, making your own playback program. (This function can not be performed while a CD is being played.)

OPERATING PROGRAM PLAYBACK

- 1 Match the cursor to the PROGRAM key and press the A Button on the controller.
- 2 Using the NUMBER KEYS, enter the number of tracks you wish to listen to and this number will automatically be entered into the memory.
 - * At this time, under the INDEX display, the number of desired tracks will be displayed, and the total amount of playback time will be displayed under TIME. Further, these two displays will display a larger number as the number of tracks is entered into the memory. For example, in the diagram on the right, 3 tracks are programmed and the total amount of program time is 10 minutes and 20 seconds.
 - * To operate the NUMBER KEYS, refer to p.17-18.
 - * During the setting of the PROGRAM, the AUTO SEARCH function can not be used. If the AUTO SEARCH function is used, the SELECT WITH 10 KEY message will appear.
- 3 Enter all of the desired tracks with the NUMBER KEYS. To correct a track setting, press the CANCEL key.
 - * To operate the CANCEL key, refer to page 18.
 - * During the PROGRAM selection, the TRACK and INDEX display will exhibit track numbers. At this time, the PROGRAM key's left lamp will illuminate.
- 4 When track input is completed, match the cursor to the PLAY (▶) symbol and press the A Button on the controller. In so doing, the PROGRAM will begin. At this time, the PROGRAM key's left lamp will flash.
 - * The track display will show the numbers and order of selected tracks.
For example, from a total of 24 tracks, tracks 1, 3, 5, 8, 14, 22, 24 have been selected to comprise a 7 track program. These 7 tracks are then displayed below.

TRACK	INDEX
08	03

L R	TIME	INTRO
	10:20	05
	ELAPSED	NORMAL

1 3 5 8 14 22 24

- 5 To clear the PROGRAM setting, press the PROGRAM key again or press the C Button on your controller.
 - * Note that when the disc is removed from the console, the set PROGRAM will consequently be deleted.

SETTING UP A MUSIC

Example: Programming tracks 2, 1, 11 from an 11-track CD.

Tracks in Memory	Contents of Memory
1	2
2	1
3	11

* When the PROGRAM key is selected, until the PLAY key is pressed, the Track Display and Index Display will flash and show the track numbers selected.

- ① Activate the PROGRAM key ② 3 is entered by mistake ③ Activate the CANCEL key ④ Return to Index 1



- ⑤ Press the 2 key ⑥ Goes to Index 2 ⑦ Press the 1 key ⑧ Goes to Index 3

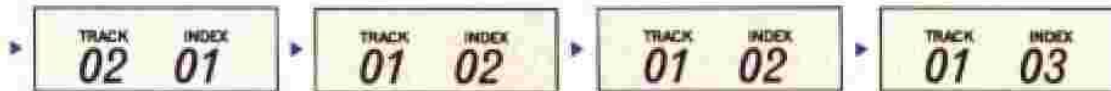

- ⑨ Press the +10 key ⑩ Press the 1 key ⑪ Press PLAY (▶) to begin the program.



● THE INTRODUCTION FUNCTION (INTRO)

[Plays the first seconds of all tracks on a particular CD (Can be set during PLAY, PAUSE and STOP).]

OPERATING THE INTRO FUNCTION

- After matching the cursor with the INTRO key and pressing the A Button on the controller, activate the PLAY key and begin the INTRO function by pressing the A Button on the controller. The INTRO key's left lamp will then flash until play is stopped.
 - Pressing the INTRO button during normal playback will start the INTRO function.
 - During PAUSE, press the INTRO key then PAUSE (||) again to begin INTRO playback.
- To cancel the INTRO function, activate INTRO a second time or press the C Button on your controller.

HOW TO ADJUST INTRO TIMES

- Move the cursor to the INTRO area on the display. INTRO time may be selected up to 2 digits (0-99).
- With the A Button or B Button of your controller, set the desired time.
 - A Button → Pressing once increases time by 1 second.
 - B Button → Pressing once decreases time by 1 second.

* During INTRO playback, the INTRO TIME can not be altered.

MUSIC FUNCTIONS (4) SPECIAL COMMANDS (B)

●●RANDOM PLAYBACK

[Automatically rearranges and plays back CD tracks. (Can be used during PLAY, PAUSE and STOP).]

USING RANDOM PLAYBACK

- 1 Match the cursor to the RANDOM key and press the A Button. When it is activated, the RANDOM key's left lamp will flash.
- 2 After that, match the cursor to the PLAY key (▶) and push the A Button on the 1-Player controller.
- 3 To cancel the RANDOM play command, match the cursor to the RANDOM key a second time and push the A Button, or push the C Button on the controller.

●●REPEAT FUNCTIONS: REPEAT 1

[Repeats only 1 track continually. (Can be used during PLAY, PAUSE and STOP).]

HOW TO USE THE REPEAT 1 FUNCTION

- 1 Use the NUMBER KEYS or the AUTOSEARCH to select the desired track.
- 2 Match the cursor to the REPEAT 1 key and press the A Button on the controller. When this function is set, the REPEAT 1 key's left lamp will flash.
- 3 After doing this, move the cursor to the PLAY key (▶) and push the A Button on the controller to begin the function.
- 4 To cancel the REPEAT 1 function, match the cursor to the REPEAT 1 key a second time and push the A Button on the controller, or simply push the C Button on the controller.

●●THE REPEAT ALL FUNCTION

[Repeats an entire CD. (This function can be selected during PLAY, PAUSE and STOP.)]

USING THE REPEAT ALL FUNCTION

- 1 Match the cursor to the REPEAT ALL key and press the A Button on the controller. When this function is set, the REPEAT ALL key's left lamp will flash.
- 2 After that, activate the PLAY key by pushing the A Button on the controller to repeat all of the CD.
- 3 To cancel the REPEAT ALL function, activate the REPEAT ALL key once again by matching the cursor to this key and pressing the A Button on the controller or press the C Button on the controller.

●●A-B REPEAT FUNCTION

[Repeats a set interval selected on the CD. (Can only be set during PLAY.)]

USING THE A-B REPEAT FUNCTION

- 1 During play, when matching the cursor to the A-B REPEAT key and pressing the A Button on the controller, point A will be determined (the point at which subsequent play will begin). In so doing, the A-B REPEAT key's left lamp will flash.
- 2 Then, let the music play to the point at which you want to end play (point B).
- 3 Select the A-B REPEAT key with the cursor and press the A Button to begin play. The music will repeat within the A-B interval.
- 4 To cancel the A-B REPEAT command, press the A-B REPEAT key once again or push the C Button on the controller.

●●TO CANCEL THE SPECIAL PLAYBACK FUNCTIONS

[For functions to be put into effect, match the cursor to the selected function and push the A Button on the controller, or simply push the C Button on the controller to cancel.]

●●WARNING MESSAGES

During play, the following messages may appear:

Message	Explanation
WAIT FOR A MOMENT	The contents of the CD are being read. (This message appears when CD is set in machine.)
INSERT CD	The CD has not been properly set within the console.
SELECT AUDIO TRACK	The selected track is within the game program. Choose another track. Interference or excessive output may result from this, so take care.
SELECT WITH 10 KEY	Appears with use of the Autosearch. Use the Number Keys to select a track.

●●ERROR CODES

When playing discs that are excessively damaged or dirty, the error message on the right may appear. The error message will also appear when the flap cover is opened in the NOW LOADING stage, or when the console receives shock on an unstable place. When this message appears, turn the console off, clean the disc, and set it again. If the error message still appears, it may be from other cause than the above, so discontinue use of the disc and consult with the store at which you bought the product.

DISK I/O ERROR
(ID=0000)
PLEASE POWER OFF

NOTES ON USE

The NEO GEO CD is a precision-made, electric console. When operating your console, we ask you to keep the following in mind.

NEO GEO CD POWER SUPPLY

- Be sure to use only the NEO GEO AC/DC ADAPTOR supplied with your NEO GEO CD. The NEO GEO AC/DC ADAPTOR can be used by connecting to the wall outlet AC 100 V to 240 V.
- Should smoke, a strange smell or sound emanate from the adaptor, immediately pull the plug out of the wall outlet and take the merchandise back to the place where it was purchased.
- Do not place flammable objects near wall outlets.
- Always disconnect the AC adaptor from the power outlet after finishing play. When removing the adaptor, please grip the base of the adaptor and remove it gently.

NOTES ON THE NEO GEO CD CONSOLE

- Do not place any objects on top of the console.
- Do not force the cover open with your hands or a tool, for this may result in damage to the console. If the flap cover should come off the console, immediately turn the power off and consult the shop where it was purchased.
- Do not attempt repairs or modifications on the console. Such attempts may result in damage to the console, or, perhaps, cause an electric shock.

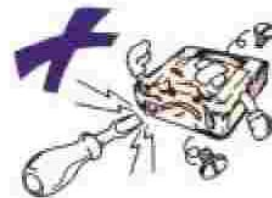

- Do not drop liquid or flammable materials inside the console. It may generate extraordinary heat in the console and result in damage to the console, an electric shock or a fire.



- Do not touch the lens inside the flap cover.
- Never look into the lens inside the flap cover while the console's power is on. It may harm your eyes.

- If the console is transferred from a cold to warm place in a short amount of time and moisture is allowed to condense on the lens of the laser pickup mechanism, turn off the power and remove the CD. Wait for roughly one hour for the moisture to evaporate.



- Do not put foreign substances within the CD cover.
- Be sure to remove CDs from the console when moving the console.
- Do not drop the unit or subject it to strong shock.
- Do not bend or pull on any of the cords. Also, avoid placing heavy objects on any of the cords.
- Be sure to turn the machine off using the power switch. Do not use the AC/DC ADAPTOR for this purpose.
- After turning your machine off once, wait at least 20 seconds to turn it on again.
- Never open the flap cover while playing game or music, or while NOW LOADING sign is displayed. This may cause damage to you or to the console.

CREATING GOOD CONDITIONS FOR USE

●● Please avoid placing your NEO GEO CD in the following conditions:

- Direct sunlight or near air-conditioning systems or heating systems.
- In damp, poorly circulated areas.
- In excessively dusty areas.
- In areas of extreme cold.
- On unstable furniture or places where it may easily fall.
- In places where the console may not rest levelly.
- In areas subject to shock or excessive shaking.
- In areas of excessive magnetic fields.
- Next to a tuner or television set.
- Next to a tuner, television set or wireless installation. (This may result in an unclear picture or a noise. Outdoor antennas are recommended instead of indoor antennas.)

GENERAL MAINTENANCE

- Do not use benzine, alcohol or thinner to clean the console or CDs.
- Do not touch the internal lens of the console.

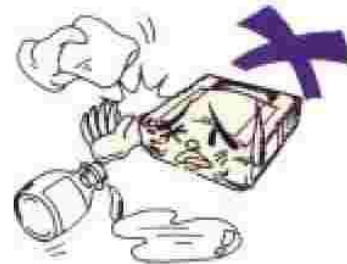

NOTES ON HANDLING CDS

- Always be careful in handling the CDs.
- When not in use, keep CDs in their protective cases.
- Do not touch the unprinted surface when handling CDs. A dirty disc may result in mis-functioning of the CD system.
- Do not bend, place stickers on CDs.
- Wipe marks, fingerprints, or dust gathered on the surface with a soft, dry cloth, wiping in a straight motion from the center out.
- Do not use an organic solvent (such as thinner) or an atomized cleaner to clean CDs.



To get the most enjoyment out of this and other NEO GEO video games, we encourage you to follow the suggestions below.

- Be sure to take a break at least once every hour. When you are very tired or are sick, it is best to refrain from playing until your body has returned to normal.
- Be sure to play video games in a bright environment at a healthy distance from the television screen.



[EPILEPSY WARNING]

Please read before playing the NEO-GEO system

- The perception of certain flashing light patterns, bright light patterns or auditory sound patterns, commonly found in our daily environment, as viewed or heard by a small segment of the population, can lead to epileptic seizures. If you have an epileptic condition, please consult your physician before playing video games. Individuals who have not experienced any previous seizures may have an undetected epileptic condition. If you experience any of the following symptoms while playing video games, consult your physician: involuntary muscle contractions, auditory seizures, altered vision, mental confusion, disorientation and convulsions.

TROUBLESHOOTING

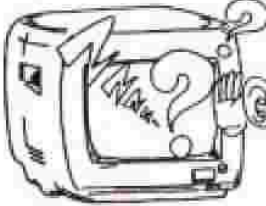
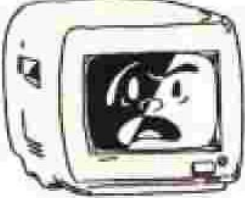
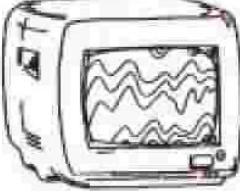
The following situations may occur during normal operation and do not necessarily mean that your console is broken. Please check the following carefully before you request assistance from the retailer or manufacturer.

PROBLEM	SOLUTION
<p>The power does not come on.</p> 	<ul style="list-style-type: none"> ■ Check to see if the AC adaptor is firmly placed in the power outlet and securely connected to the console.
<p>There is no picture or sound.</p> 	<ul style="list-style-type: none"> ■ Is the power cord of your television plugged into the outlet? ■ Has the power switch been turned on to your television? ■ Is the TV set to the right channel or video setting? ■ Is the volume adjusted to an audible level? ■ Is the AC adaptor connected properly? ■ Has the appropriate cable and connection method been employed?
<p>The picture appears in black and white. The color is not matched with the image.</p> 	<ul style="list-style-type: none"> ■ Adjust the picture control of your television. (Check Brightness, Contrast, Shade, Tone, and so on.)
<p>The picture flickers or is generally unstable.</p> 	<ul style="list-style-type: none"> ■ Adjust the vertical or horizontal hold of your television.
<p>There is no sound.</p> 	<ul style="list-style-type: none"> ■ Check the volume of your television, amplifier, or other machine that you're sending the sound through. ■ Have all connections been made properly? ■ Has the disc been inserted upside down? ■ Is there excessive build up of dust on the surface of the CD in use? ■ Check if the Stereo Audio Cord (included in the NEO GEO Stereo AV cords) is not connected to the monaural television. (See page 6 for connecting.)

■ NEO GEO CD CONSOLE SPECIFICATIONS ■

MODEL NAME:	NEO GEO-CD
MODEL NO.:	T1-CDP
ITEM NO.:	CD-T01
POWER SOURCE:	AC 110 V-240 V 50/60 Hz
POWER CONSUMPTION:	29W
PREFERRED CONDITIONS FOR USE:	Temperature/0°C-35°C (indoors) Humidity/30%-85%
PERIOD OF BACK-UP DATA STORAGE:	Two weeks
ACCEPTED CD:	NEO GEO CD Music CD (8 cm and 12 cm)
DIMENSIONS:	285 mm (width) × 285 mm (depth) × 95 mm (height)
WEIGHT:	2.1 kgs

■ SET CONTENTS ■

MAIN CONSOLE × 1
NEO GEO CD PAD CONTROLLER × 2
AC/DC ADAPTOR × 1
RF or AV or RGB CABLE × 1
INSTRUCTION BOOKLET × 1

■ OPTIONAL ACCESSORIES ■

NEO GEO CD PAD CONTROLLER
NEO GEO CD JOY-STICK CONTROLLER
NEO GEO CD AC/DC ADAPTOR
NEO GEO CD STEREO AV CABLE SET
RGB CABLE
RF CONVERTER

* Alterations to the product and contents of the manual are subject to change for improvements without notice.

* Business Use and Rental prohibited.



The Future Is Now
SNK

SNK CORPORATION
SNK BLDG., 18-12 TGYOTSU-CHO, SUITA-SHI, OSAKA, 564, JAPAN
TELEPHONE: (81) 6-338-5577 FAX: (81) 6-338-7175

Printed in Japan
ALL RIGHTS RESERVED BY SNK CORPORATION