

**Interactive
Media
Systems**

CD-I



CDI 605

**COMPACT
disc
Interactive**

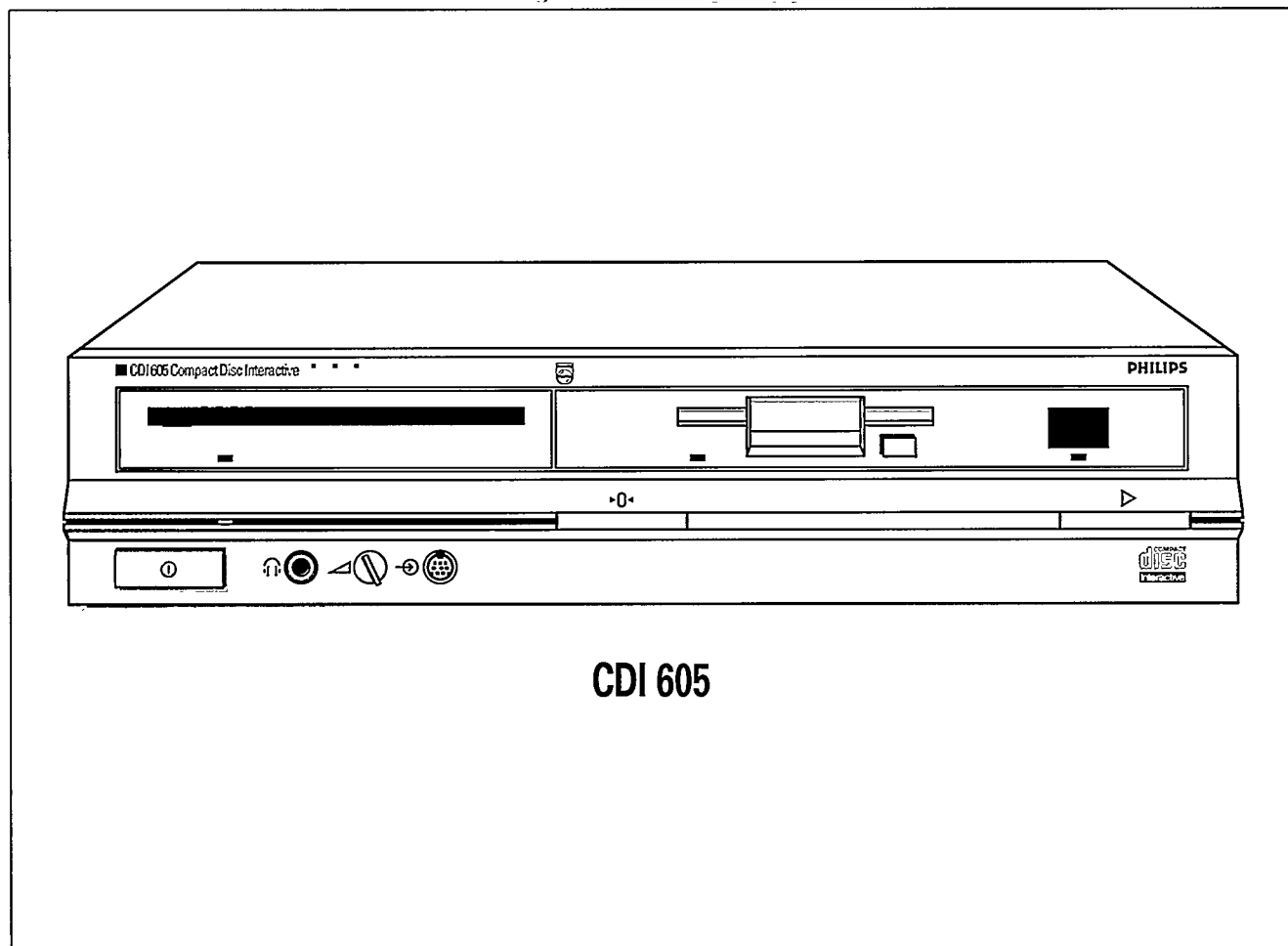

CDI 605

USER MANUAL



PHILIPS

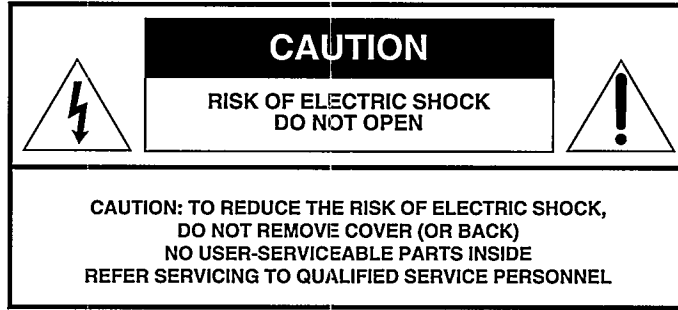

The lightning flash with arrowhead symbol, within an equilateral triangle, is intended to alert the user to the presence of uninsulated "dangerous voltage" within the product's enclosure that may be of sufficient magnitude to constitute a risk of electric shock to persons.



The exclamation point within an equilateral triangle is intended to alert the user to the presence of important operating and maintenance (servicing) instructions in the literature accompanying the appliance.

WARNING

TO REDUCE THE RISK OF FIRE OR ELECTRIC SHOCK, DO NOT EXPOSE THIS APPLIANCE TO RAIN OR MOISTURE.

CAUTION

TO PREVENT ELECTRIC SHOCK DO NOT USE THIS (POLARIZED) PLUG WITH AN EXTENSION CORD, RECEPTACLE OR OTHER OUTLET UNLESS THE BLADES CAN BE FULLY INSERTED TO PREVENT BLADE EXPOSURE.

ATTENTION

POUR PRÉVENIR LES CHOCS ÉLECTRIQUES NE PAS UTILISER CETTE FICHE POLARISÉE AVEC UN PROLONGATEUR, UNE PRISE DE COURANT OU UNE AUTRE SORTIE DE COURANT, SAUF SI LES LAMES PEUVENT ÊTRE INSÉRÉES À FOND SANS EN LAISSER AUCUNE PARTIE À DÉCOUVERT.

LASER SAFETY

This unit employs a laser. Only a qualified service person should remove the cover or attempt to service this device, due to possible eye injury.

"CAUTION - USE OF CONTROLS OR ADJUSTMENTS OR PERFORMANCE OF PROCEDURE OTHER THAN THOSE SPECIFIED HEREIN MAY RESULT IN HAZARDOUS RADIATION EXPOSURE."

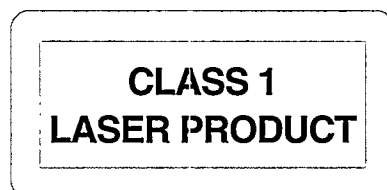

Open this flap to read
important instructions

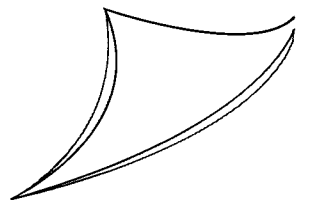

FRONT VIEW

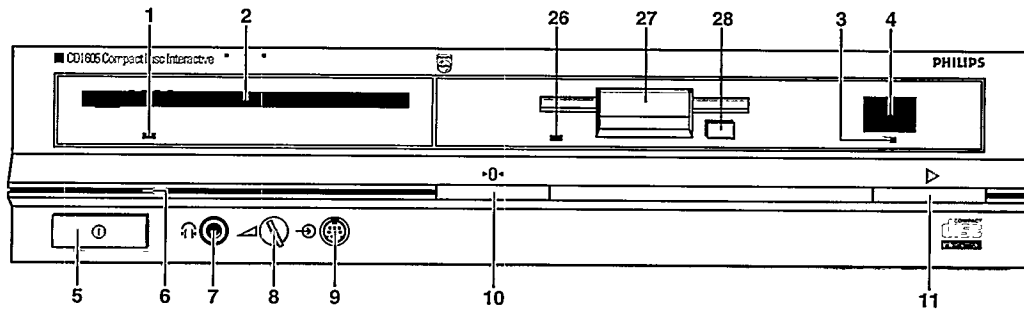

REAR VIEW

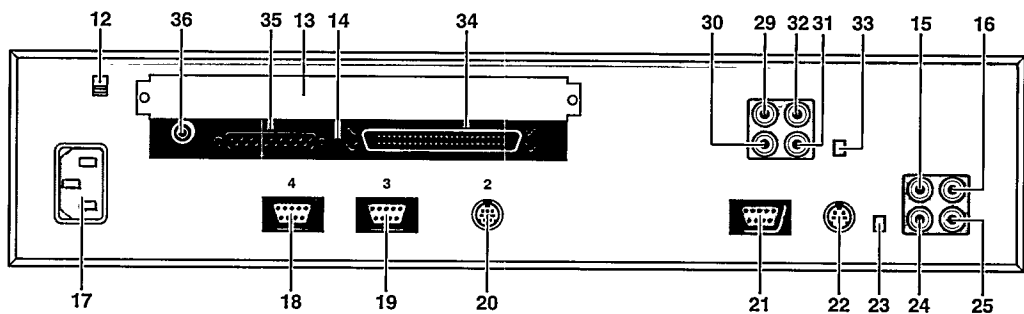

CDI 605 FRONT PANEL

- 1. "Reading Disc" indicator
- 2. Caddy loading slot
- 3. Remote Control indicator
- 4. Infra-red sensor
- 5. Power On/Off button
- 6. Power On indicator
- 7. Headphone socket
- 8. Headphone volume control
- 9. Control Port 1
- 10. "Return to zero" button
- 11. Start/Play button
- 26. Floppy Disc Drive indicator
- 27. Floppy Disc Drive 3.5"
- 28. Floppy Disc Drive eject button

CDI 605 REAR PANEL

- 12. Voltage selector 110/220V
- 13. Extension slot 2
- 14. Extension 22 ER 9132
- 15. Audio L channel connector
- 16. CVBS (Video) connector
- 17. Power connector
- 18. Port 4 RS 232 C
- 19. Port 3 RS 232 C
- 20. Control Port 2
- 21. RGB connector
- 22. Y/C (S-Video) connector
- 23. 525/625 line selector
- 24. Audio R channel connector
- 25. Remote control bus connector
- 29. R.S Out
- 30. Digital Out/Input
- 31. Remote Switch
- 32. Not connected
- 33. CD Drive selector
- 34. SCSI Interface
- 35. Printer Port
- 36. Ethernet "Thin Wire" Connector

READ BEFORE OPERATING EQUIPMENT

This product was designed and manufactured to meet strict quality and safety standards. There are, however, some installation and operation precautions which you should be particularly aware of.

1. **Read Instructions** - All the safety and operating instructions should be read before the appliance is operated.
2. **Retain Instructions** - The safety and operating instructions should be retained for future reference.
3. **Heed Warnings** - All warnings on the appliance and in the operating instructions should be adhered to.
4. **Follow Instructions** - All operating and use instructions should be followed.
5. **Cleaning** - Unplug this product from the wall outlet before cleaning. Do not use liquid cleaners or aerosol cleaners. Use a damp cloth for cleaning.
6. **Attachments** - Do not use attachments not recommended by the product manufacturer as they may cause hazards.
7. **Water and Moisture** - Do not use this product near water - for example, near a bath tub, wash bowl, kitchen sink, or laundry tub, in a wet basement, or near a swimming pool, and the like.
8. **Accessories** - Do not place this product on an unstable cart, stand, tripod, bracket, or table. The product may fall, causing serious injury to a child or adult, and serious damage to the appliance. Use only with a cart, stand, tripod, bracket, or table recommended by the manufacturer, or sold with the product. Any mounting of the appliance should follow the manufacturer's instructions, and should use a mounting accessory recommended by the manufacturer.
9. **Ventilation** - Slots and openings in the cabinet are provided for ventilation and to ensure reliable operation of the product and to protect it from overheating, and these openings must not be blocked or covered. The openings should never be blocked by placing the product on a bed, sofa, rug, or other similar surface. This product should never be placed near or over a radiator or heat register. This product should not be placed in a built-in installation such as a bookcase or rack unless proper ventilation is provided or the manufacturer's instructions have been adhered to.
10. **Power Sources** - This product should be operated only from the type of power source indicated on the marking label. If you are not sure of the type of power supply to your home, consult your appliance dealer or local power company. For products intended to operate from battery power, or other sources, refer to the operating instructions.
11. **Grounding or Polarization** - This product is equipped with a 3 wire grounding type plug, a plug having a third (grounding) pin. This plug will only fit into a grounding type power outlet. This is a safety feature. If you are unable to insert the plug fully into the outlet contact your electrician to replace your obsolete outlet. Do not defeat the safety purpose of the grounding type plug.
12. **Power-Cord Protection** - Power-supply cords should be routed so that they are not likely to be walked on or pinched by items placed upon or against them, paying particular attention to cords at plugs, convenience receptacles, and the point where they exit from the appliance.
13. **Extension Cord** - If an extension cord is used with this product, make sure that the total of amperage ratings of the products plugged into the extension cord do not exceed the extension cord amperage rating. Also make sure that the total of all products plugged into the wall outlet does not exceed 15 amperes.
14. **Object and Liquid Entry** - Never push objects of any kind into this product through openings as they may touch dangerous voltage points or short-out parts that could result in a fire or electric shock. Never spill liquid of any kind on the product.
15. **Service** - Do not attempt to service this product yourself as opening or removing covers may expose you to dangerous voltage or other hazards. Refer all servicing to qualified service personnel.
16. **Damage Requiring Service** - Unplug this product from the wall outlet and refer servicing to qualified service personnel under the following conditions:
 - a. When the power-supply cord or plug is damaged.
 - b. If liquid has been spilled, or objects have fallen into the product.
 - c. If the product has been exposed to rain or water.
 - d. If the product does not operate normally by following the operating instructions. Adjust only those controls that are covered by the operating instructions as an improper adjustment of other controls may result in damage and will often require extensive work by a qualified technician to restore the product to its normal operation.
 - e. If the product has been dropped or the cabinet has been damaged.
 - f. When the product exhibits a distinct change in performance - this indicates a need for service.

ATTENTION TO CUSTOMER

In order to avoid the risk of electrical shock and mechanical hazard, please follow these instructions:

1. For units set at 120-127 V: use a UL listed cord set consisting of a minimum 18 AWG, type SVT or SJT three conductor cord a maximum of 15-feet in length and a parallel blade, grounding type attachment plug rated 15 A, 125 V.
For units set at 220-240 V (domestic use USA): use a UL listed cord set consisting of a minimum 18 AWG, type SVT or SJT three conductor cord a maximum of 15-feet in length and a tandem blade, grounding type attachment plug rated 15 A, 250 V.
For units set at 220-240 V (outside of USA): use a cord set consisting of a minimum 18 AWG cord (H05-VVF) and grounding type attachment plug rated 15 A, 250 V. The cord set should have the appropriate safety approvals for the country in which the equipment will be installed and marked HAR.
 2. Extension boards may only be used when UL listed.
 3. For Installation or replacement of extension boards, the user should carefully read the installation procedure bypacked with the extension board.
 4. Do not operate the CD-I system without cover and do not operate the CD-I system without extension boards in extension slots mounted and fixed to the chassis with screws.
-

INFORMATION TO USER READ CAREFULLY

THIS DIGITAL APPARATUS DOES NOT EXCEED THE CLASS A LIMITS FOR RADIO NOISE EMISSIONS FROM DIGITAL APPARATUS AS SET OUT IN THE RADIO INTERFERENCE REGULATIONS OF THE CANADIAN DEPARTMENT OF COMMUNICATIONS.

LE PRÉSENT APPAREIL NUMÉRIQUE N'ÉMET PAS DE BRUITS RADIOÉLECTRIQUES DÉPASSANT LES LIMITES APPLICABLES AUX APPAREILS NUMÉRIQUES DE CLASSE A PRESCRITES DANS LE REGLEMENT SUR LE BROUILLAGE RADIOÉLECTRIQUE EDICTÉ PAR LE MINISTÈRE DES COMMUNICATIONS DU CANADA.

Note: This equipment has been tested and found to comply with the limits for a Class A digital device, pursuant to Part 15 of the FCC Rules. These limits are designed to provide reasonable protection against harmful interference when the equipment is operated in a commercial environment. This equipment generates uses, and can radiate radio frequency energy and if not installed and used in accordance with the instruction manual may cause harmful interference to radio communications. Operation of this equipment in a residential area is likely to cause harmful interference in which case the user will be required to correct the interference at this own expense.

IMPORTANT

This product was FCC certified under test conditions that included use of shielded cables and connectors between systems components. It is important that you use shielded cables to reduce the possibility of causing interference to radios, television sets and other electronic devices. If you have any problems contact your dealer.

The user may find the following booklet prepared by the Federal Communications commission helpful:

"How to Identify and Resolve Radio - TV Interference Problems".

This booklet is available from the U.S. Government Printing Office, Washington, DC 20402, Stock No. 004-00345-4.

Any change or modifications to the equipment by the user not expressly approved by the granty or manufacturer could avoid the user authority to operate such equipment.

CONTENTS

	Page
WELCOME TO CDI-1	7
IMPORTANT SAFEGUARDS	7
INSTALLATION	7
Positioning	
Settings	
CONNECTIONS	8
Video	
Audio	
Power Supply	
SYSTEM EXTENSION, COMMUNICATION AND INTERFACING	9
Pointing Device	
Other Pointing Devices and Controllers	
RS 232-C Ports	
Emulator	
SCSI	
Ethernet	
Printer Port	
Extension Slots	
INTERACTIVE OPERATION	10
The disc caddy	
Fitting a disc in the caddy	
Loading a disc	
Unloading a disc	
Preparation	
The 605 Tools menu	
The SETTINGS Screen	
The DIM Function	
The INFO Screen	
The MEMORY Screen	
Running a CD-I disc on the internal drive	
Running a CD-I disc on an external drive	
Running CD-I discs	
Playing CD-Audio discs	
Creating FTS Titles	
Push-button Control	
CD-Graphics	
Switching Off	
CLEANING AND DISC CARE	16
TECHNICAL DATA	16
Technical data	
Connector signals and pinning	
BEFORE REQUESTING SERVICE	18
REGISTRATION	18
GUARANTEE & SERVICE	18

WELCOME TO CD-I

This Compact Disc Interactive (CD-I) system is designed to run discs conforming to the CD-I standard. It will also play CD-Audio discs and the audio tracks of 12 cm LaserDiscs, and can be extended for use as a CD-ROM drive. Extension slots and RS 232-C I/O ports allow for the connection of peripherals and communication devices, for memory extension and for server/networking configurations to suit specific applications, including CD-ROM. The floppy disc drive of the CDI 605 is a versatile system-specific storage and retrieval facility.

IMPORTANT SAFEGUARDS

Before attempting to install or operate this appliance, please read the Important Safeguards under the front cover flap.

INSTALLATION

Positioning

Place the system on a firm flat surface. Keep away from heat sources and direct sunlight. In a cabinet, allow 2-3 cm of free space all round for ventilation.

Settings

For correct settings see this user manual and/or the Technical Manual.

CONNECTIONS

For cables other than those supplied, please contact your national Philips organization.

CAUTION: never make or change connections (other than the headphone) with the power switched on. It is advisable to make all other connections before connecting power.

Video

- Three video outlets are located on the rear panel. In order of preference to obtain the best achievable picture quality, they are:

- RGB
- Y/C (S-Video)
- CVBS (Video)

Connect the outlet that will give the best picture quality on the display unit used.

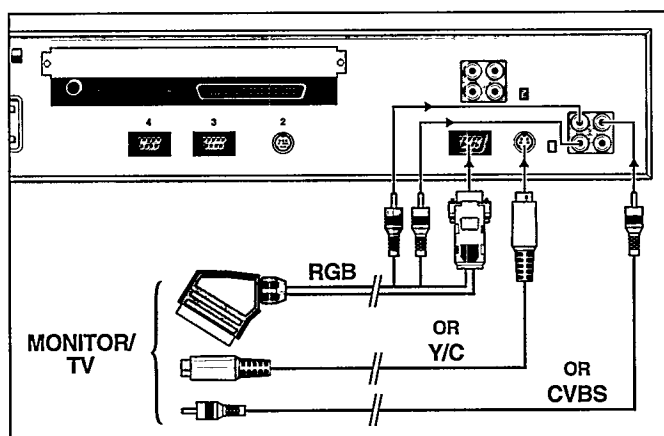

- RGB Connection:** this D-sub connector supplies analog RGB signals at the voltage level given in the Technical Data section. This outlet is not compatible with the connectors of the same type used on computer terminals. Connect to the display unit using an RGB cable (Supplied in Europe).
 - Y/C Connection:** connect to the display unit Y/C (S-Video) socket using a Y/C (S-Video) cable.
 - CVBS (Video) Connection:** connect to the display unit CVBS (Video) socket using a CVBS (Video) cable (Supplied in USA).
- 525/625 Line selector switch
Before switching on the system, make sure that the Line Selector switch on the rear panel is set to the correct position for the display unit:
525 for NTSC
625 for PAL

Audio

- Sound reproduction via the display unit:**
Connect the L and R Audio sockets to the L and R audio sockets on the display unit using the cable supplied (USA). Match the colours of the plugs and sockets.
Note. When the RGB outlet is used, these connections are made through flying leads on the RGB cable.
- Sound reproduction via a HiFi stereo system:**
Connect the L and R audio sockets to the CD, TV, AUX,

Tuner or Tape in sockets of the audio amplifier using the cable supplied (USA). Match the colours of the plugs and sockets.

CAUTION: Do not connect to the amplifier Phono sockets.

- Headphone sound:**

For individual listening, connect a headphone to the front panel socket.

Note. Connecting a headphone does not mute the loudspeaker sound. This must be done manually, on the display unit or HiFi system, if required.

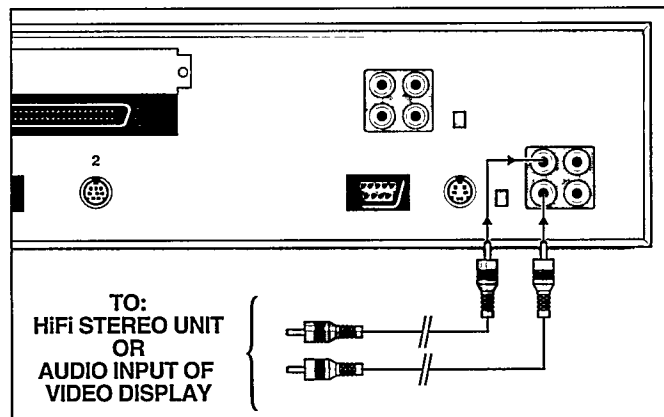

Power Supply

- Fitting a power supply plug (UK only)
WARNING: THIS APPLIANCE MUST BE EARTHED.

If you have to fit a mains plug, proceed as follows:

The wires in the mains lead are coloured:

Green and Yellow-Earth Blue-Neutral Brown-Live
As these colours may not correspond with the colour markings identifying the terminals in your plug proceed as follows:

The wire which is coloured Green and Yellow must be connected to the terminal which is marked with the letter E or by the earth-symbol or coloured Green or Green and Yellow.

The Brown wire must be connected to the terminal which is marked with the letter L or coloured Red.

The Blue wire must be connected to the terminal which is marked with the letter N or coloured black.

Note. This apparatus must be protected by a 3 amp fuse if a 13 amp plug is used, or, if any other type of plug is used, by a 5 amp fuse either in the plug or adaptor, or at the distribution board. If in doubt consult a qualified electrician.

- Voltage Setting

Make sure that the Voltage Selector switch on the rear panel is set to the correct position:

100-120 V for the USA/JAPAN

220-240 V for Europe

CAUTION: Do not connect power until this switch has been correctly set.

- Power Connection

Connect the power supply cable between the power connector on the rear panel and a power supply socket.

Pointing Device

The mouse supplied is generally suitable for all applications. Connect it to dedicated CD-I pointing device port 1 on the front panel or to general CD-I I/O port 2 on the rear panel.

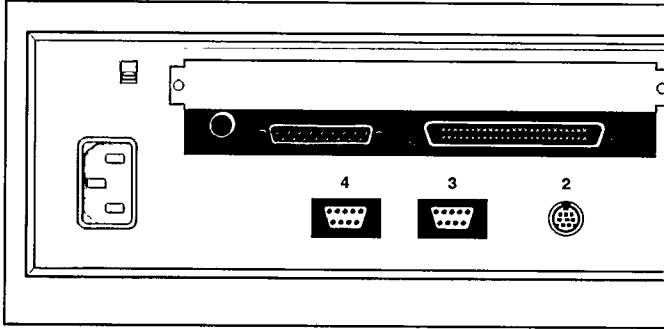

CAUTION: For correct operation, connections to all I/O ports must be made with the power off.

Other Pointing Devices and Controllers

For some applications, other types of pointing devices, keyboards or controllers may be required. The types defined in the CD-I Pointing Devices and Keyboards specifications, which can be connected through the CD-I I/O ports 1 and 2, will usually suffice. For specific applications, however, the range of special devices that can be connected is virtually unlimited. For further information on this subject, please contact your national Philips organization.

A CD-I remote control (22ER 9051) can be used also for all point and click functions.

RS 232C Ports

I/O ports 3 and 4 (D-sub 9) on the rear panel can be used for general RS 232C based devices according to the application. Further information on this subject can be found in the CD-I Technical Manual.

Depending on the application, RS 232C based devices may also be connected to CD-I I/O port 2.

Emulator

- The emulator signal connectors are located on the rear panel, the following signals are available:
 - A. RS
 - B. DO
 - C. SWITCH

A. RS connection: this cinch connector provides commands for the external drive(s) or emulator.

B. DO (Digital Out) connection: this cinch connector is an input for DO signals from the external drive(s) or emulator.

C. SWITCH connection: with this cinch connector the emulator interface can be switched over from internal to external and vice versa.

- Internal/External emulator switch

When the emulator interface is not used the emulator switch on the rear panel should be set to the 'Internal' position.

SCSI

- The SCSI (50 pins microribbon) connector is located on the rear panel. In the standard configuration it supports the interfacing to an SCSI harddisk. For other SCSI applications, please contact your national Philips organization.

Ethernet

- The Ethernet (thin wire, BNC) connector is located on the rear panel. It serves as an interface to all thin wire based LAN's using TCP/IP.

Printer Port

- The printer (25 pins SUBD) connector is located on the rear panel. This interface is fully compatible with the IBM PC* implementation.

Extension Slots

One extension slot is provided for fitting standard extension and/or customized interface cards according to the application.

For information relating to the supply of extension cards, please contact your national Philips organization.

* IBM, IBM-PC are the trade marks from International Business Machines Cooperation.

In normal interactive operation, the mouse is used to select functions displayed on the display unit. Simply roll the mouse

INTERACTIVE OPERATION

on a flat, smooth surface to point the cursor arrow on the screen to the required function, and then press one of the two action buttons. In general "one dot" to activate, "two dots" to call/remove the menu. The function is highlighted to confirm the selection.

The disc caddy

All discs must be loaded and unloaded using a special protective caddy. Three caddies are supplied with the system. **CAUTION:** Never attempt to load a disc without a caddy: this is likely to damage the disc and will jam the loading mechanism.

Fitting a disc in the caddy

If necessary, remove the disc holder from the caddy by pushing the two disc holder latches downwards and outwards with a pointed implement such as a ball-point pen to release them, and then sliding the holder out of the caddy sleeve.

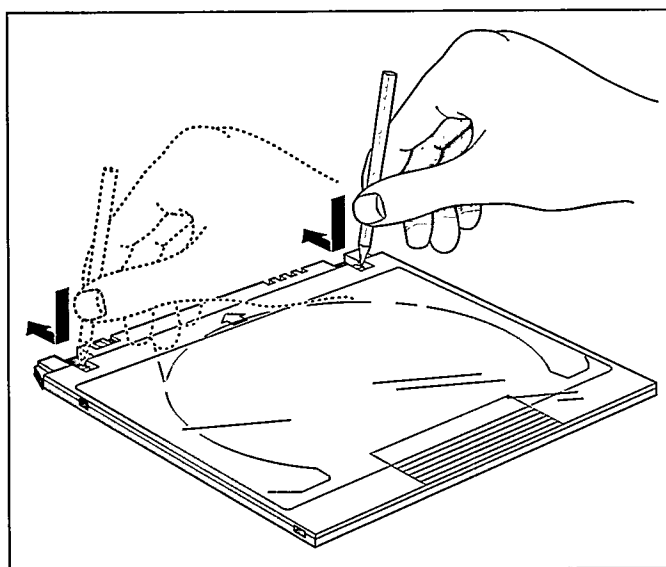

Hold the disc holder by the two arms with the small arrow mark on the rear edge facing upwards. Holding the disc by the centre with the label upwards, fit it into the locating grooves in the disc holder arms. Slide the disc holder back into the caddy sleeve.

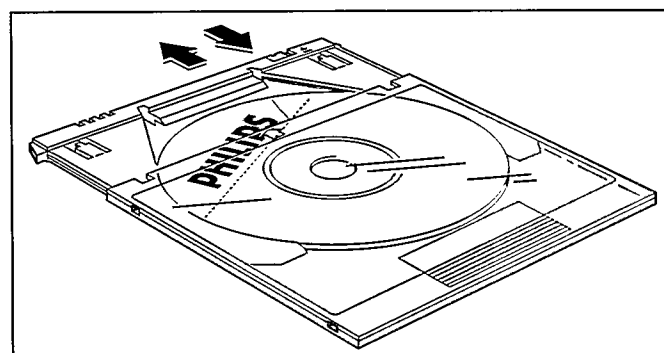
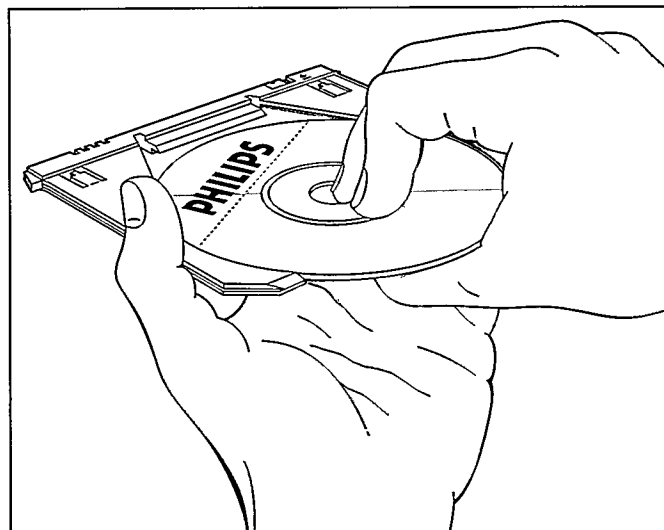

Loading a disc

Holding the caddy by the sleeve, with the small arrow mark on the rear edge facing upwards, push it fully into the loading slot, allow it to spring back about half an inch (10-15 mm), and then withdraw the sleeve; the disc and holder remain in the system.

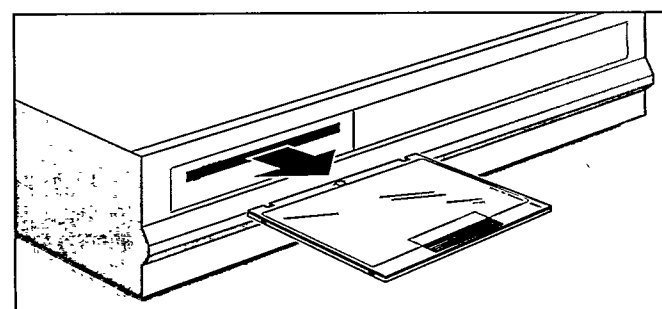
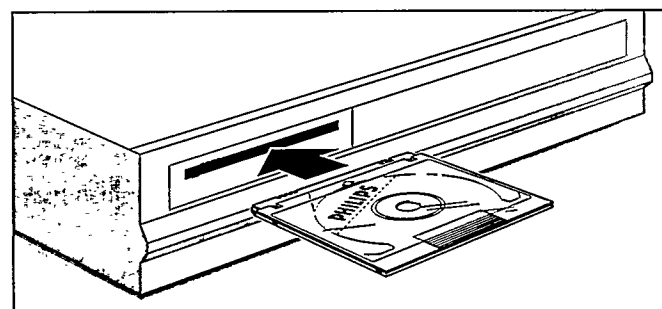

Unloading a disc

Unloading is the reverse of loading. Push an empty caddy sleeve fully into the loading slot, allow it to spring back about half an inch (10-15 mm), then withdraw the caddy complete with disc and holder.

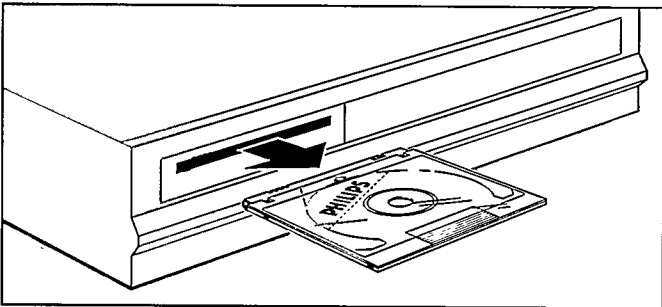
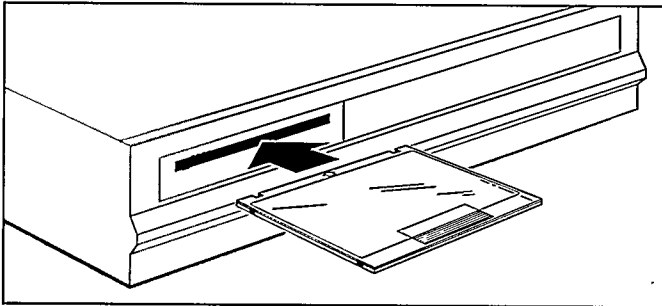

Preparation

- Press the Power On/Off button on the front panel, and check that the Power On indicator lights.
- **Note.** The "Reading Disc" indicator also flashes briefly.
- Switch on the TV (and HiFi system, if used).
- Select the CD-I input on the TV (and HiFi system, if used).
- **Note.** Connecting a headphone does not mute the loudspeaker sound. This must be done manually, on the display unit or HiFi system, if required.
- On the TV, the Player Start-Up screen appears. This screen has four system functions to guide and assist you Select:

PHILIPS

COMPACT
disc
Interactive

PLAY
CDI



INFO

SETTINGS

DIM

MEMORY

RAM: 4.0
TOOLS

Start-up Screen

- INFO if you need help during start-up, or when playing CD-Audio discs.
- SETTINGS to preselect your preferred start-up conditions.
- DIM to reduce the screen brightness while the system is at rest.
- MEMORY to refer to the titles and FTS programs you give to CD-Audio discs.

The 605 Tools menu

The Start-up screen in the CD-I 605 has an extra icon. This icon, located in the lower right corner, displays the amount of extended memory (in Mbyte) the system has. Select this icon to call up the CD-I 605 Tools menu.

Note. It may take a while after power on before the Startup screen appears. This is depending on the amount of additional memory that is set in the CD-I 605 Tools menu.

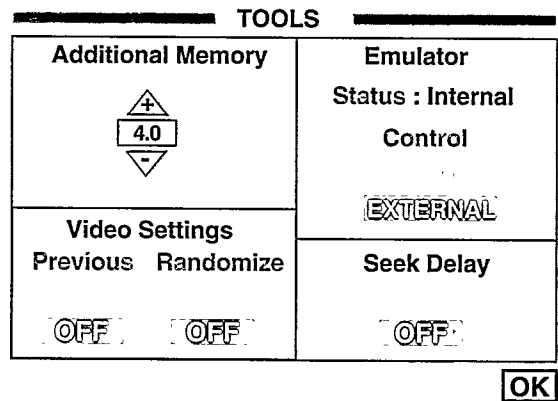

- This menu gives some extra functionality to be used in the authoring environment. Herewith one is able to simulate some worst case and/or base case conditions for evaluation of CD-I applications (by means of an external cd-drive (Emulator) or the internal cd-drive).
- Select in the Additional Memory area the INC or DEC icon to increase resp. decrease the amount of extended memory. The amount of memory is displayed in MegaBytes in steps of 0.5 Megabyte.
- Select the Seek Delay icon to switch ON/OFF the cd seek delay (conform F.F.G.B.).
- Select in the Emulator area the CONTROL INT/EXT icon to change drive communication to internal or external. The current status is displayed.

If the status does not change when changing to internal or external, please check if the remote switch (cinch) is in use. The CONTROL INT/EXT overrules the CD-DRIVE selector (on the rear).

- Select in the Video Settings area the RAND ON/OFF icon to select randomized or default video registers settings. Select the PREVIOUS icon to recall the previous randomized video register settings.

- Select the OK icon to return to the Start-up menu.
- Note.** If changes are made in the amount of additional memory, selecting OK will cause a hardware reset.

The SETTINGS Screen

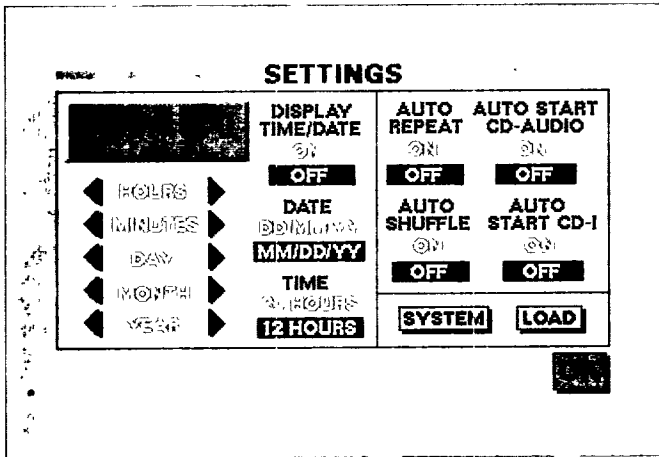

Setting Screen

AUTO START CD-I, AUTO START CD-AUDIO*, AUTO SHUFFLE* and AUTO REPEAT*

For all these functions, select "ON" to activate the function automatically when a disc is loaded.

* These are CD-AUDIO functions.

SYSTEM

System only appears for special configurations or for service purposes when a terminal is connected. Selecting SYSTEM gives access to the operating system. For further information please refer to the CDI Technical Manual.

LOAD (CDI 602 only)

Select LOAD if the system or application requires the use of a personal memory device such as the floppy disc drive for system configuration. For this purpose, specially formatted devices are defined by the application or available from your supplier.

DISPLAY TIME/DATE

Select ON to display the time and date in the Start-up and CD-Audio screens.

DATE

Select DD/MM/YY to present date in day-month-year sequence
Select MM/DD/YY to present date in month-day-year sequence

TIME

Select 24 HOURS or 12 HOURS clock

TIME/DATE SET

Select the ► and ◀ arrows to set Hours, Minutes, Day, Month and Year in turn, as required.

When finished, point-and-click on OK.

The DIM function

Selecting DIM reduces the brightness of the displayed picture. Selecting it a second time, or moving the cursor away from the icon, restores the normal brightness. Use DIM to avoid screen

burn-in if long-duration still pictures such as the Start-up screen are to be displayed while the system is waiting to be used.

The INFO Screen

The INFO screen offer help related to the operating mode. When finished, point-and-click on OK.

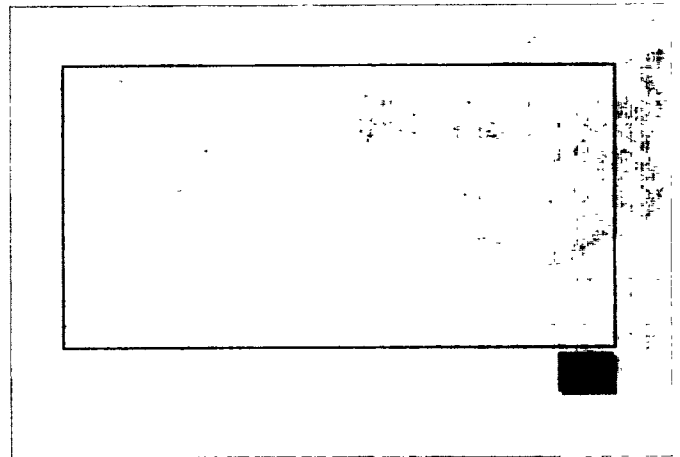

Info Screen

The MEMORY Screen

The MEMORY Screen shows the information held in non-volatile memory: titles, dates and percentage of memory used. Use the scrolls arrows to move up and down the list.

To delete an item, click on its title and then click on DELETE. If you change your mind after deleting, click on UNDO. When finished, point-and-click on OK.

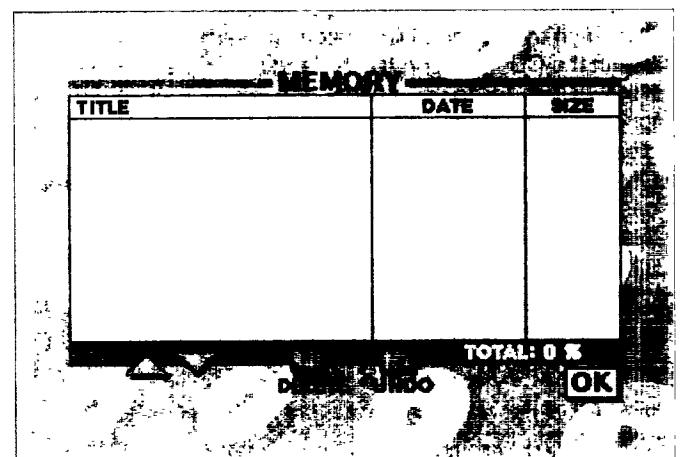

Memory Screen

Running a CD-I disc on the internal drive

- Switch the emulator interface to internal. This can be achieved by changing the control in the 605 Tools menu or by means of an external signal on the remote switch input on the rear.

Running a CD-I disc on an external drive

- Switch the emulator interface to external. This can be achieved by changing the control in the 605 Tools menu or by means of an external signal on the remote switch input on the rear.

Note. For further information please refer to the CDI6XX technical manual.

Running CD-I discs

Note. This procedure can also be used for CD-I Ready, CD-I Bridge discs and Photo-CD's. After loading the disc, the CD-I Start-up screen appears on the TV.

- Loading**
Load the disc using the caddy: on system front panel, the Reading Disc indicator flashes briefly, then lights continuously, and on the screen, the CD-I Start icon appears.
- Program Start**
To start the CD-I program, select the Start icon on the screen, or press the Start/Play key ► on the system front panel.

Note. If AUTO START CD-I ON has been selected on the SETTINGS screen, the CD-I program will start automatically. AUTO START CD-I not valid for extension drive or emulator.

From this point, all interaction is between the user and the disc program. Whenever the disc is being read, the Reading Disc indicator flashes on the system front panel. To stop at any time, select the stop or exit function provided by the program, or press the Return to Zero ►◀ on the system front panel. The disc then stops and the CD-I Start screen reappears.

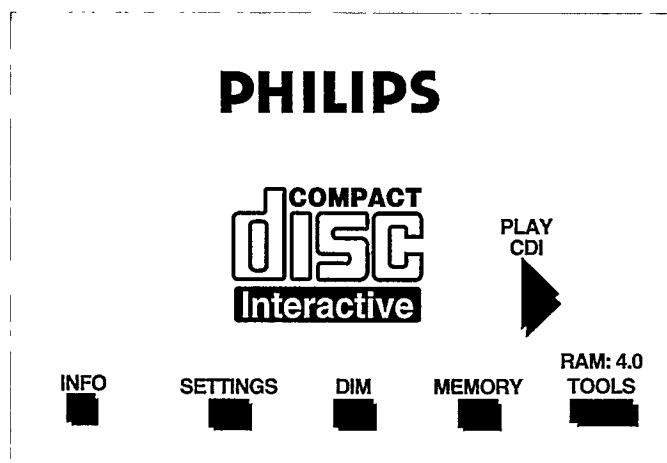

CD-I Start-up Screen

- Unloading**
Remove the disc using the caddy: on the system front panel, the Reading Disc indicator flashes briefly and then goes out, and on the display the Start-up screen reappears.

Note. The disc should not be unloaded while the CD-I program is running, unless the program asks for it.

Playing CD-Audio discs

Note. This procedure can also be used for audio sections on 5 inch (12 cm) Laser Discs.

- Loading**
Load the disc using the caddy: on the system front panel, the Reading Disc indicator flashes briefly and then lights continuously, and on the display, the CD-Audio screen appears.

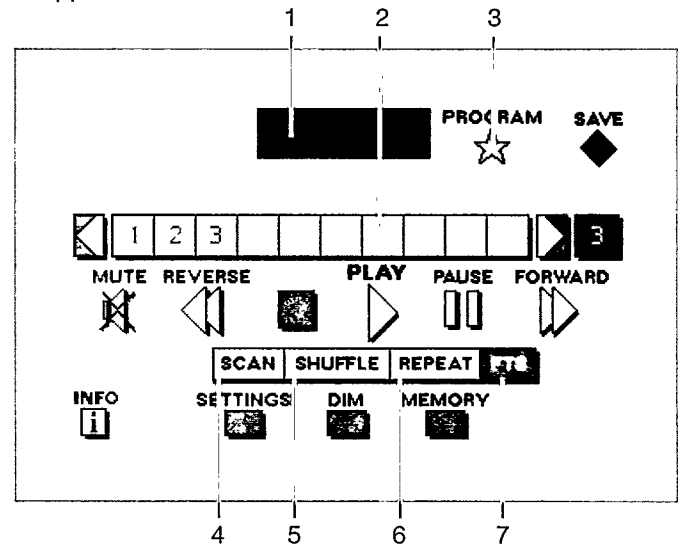

CD-Audio Screen

- Track Time window
- Play Track bar
- PROGRAM star
- SCAN
- SHUFFLE
- REPEAT
- FTS

1. Track/Time window:

After loading shows total number of tracks and total playing time. In all play and pause modes shows track number and elapsed or remaining track playing time. To change between elapsed and remaining time, select the time in the window. In all stop modes shows the last track number played and its playing time. If another track in the play track bar is selected, shows track number and playing time. If the total tracks icon in the play track bar is selected, shows total number of tracks and total playing time.

2. Play Track Bar:

Shows up to 10 track numbers and the total number or tracks. You can point-and-click to select any track. For discs with more than 10 tracks, the forward > and reverse < scroll arrows at the right and left of the track bar are used to move through the track list. The total number of tracks is shown in the box to the right of the bar, you can point-and-click it to display time in the Track Time window.

3. PROGRAM star

Allows you to program a list of special tracks called a Favorite Track Selection. When you select this star, the cursor arrow changes to a star, the FTS track bar appears above the Play track bar and the SAVE diamond beside the PROGRAM star.

4. SCAN

Allows you to listen to the beginning of every track listed in the Play track bar.

5. SHUFFLE

Allows you to play the tracks in the Play track bar in a random order.

6. REPEAT

Allows you to repeat the entire disc.

7. FTS

Allows you to play Favorite Track Selections. This icon only appears if a Favorite Track Selection has been created for the disc that is loaded in the player.

- Disc play

All the disc play control functions are shown on the screen, and can be selected as desired. The operation of the functions is briefly explained in the following table. For further guidance, consult the INFO screen.

Note. If AUTO START CD-AUDIO ON, AUTO SHUFFLE ON or AUTO REPEAT ON have been selected on the SETTINGS screen, these functions are activated automatically.

Note. Disc play can be started and stopped using the Start/Play ► and Return to Zero ►0◀ buttons on the system front panel respectively.

Note. When play starts, adjust the sound level as required.

Operation	Select	Remarks
Start play	PLAY	Starts at the beginning of Track 1, or any other preselected track number. If a track is already playing it is restarted.
Select a track	Track number	If the disc has more than 10 tracks, use the left < and right > scroll arrows to move through the track numbers as required.
Pause	PAUSE	Use to interrupt play.
Exit Pause	PAUSE or PLAY	Play restarts at exactly the same point as pause was selected.
Forward search	FORWARD	Searches forward through disc, first slowly, then fast.
Reverse search	REVERSE	Searches backwards through disc, first slowly, then fast.
Stop Play	STOP	If Play is re-started, it begins at the first track in the track bar.
Mute the Sound	MUTE	
Restore the Sound	MUTE	
Scan the disc	SCAN	Plays the beginning of each track on the disc.
Exit scan	SCAN	Normal play starts from this point.

Shuffle play	SHUFFLE	Shuffle sequence appears in track bar start playing.
Exit Shuffle	SHUFFLE	Normal play starts from this point.
Repeat	REPEAT	Repeats entire disc (or FTS program), as selected on the Settings screen.
Exit Repeat	REPEAT	
Play FTS	FTS	Only available when an FTS program has already been created for the disc in the player.
Exit FTS	FTS	Normal play starts from this point.
Program FTS	PROGRAM star	Point to tracks as required on the Play Track bar, and in each case click on any action button twice to record the track in the FTS track bar. To insert a track in the FTS track bar, click once where you want it to go, then click two times on the desired number in the play track bar. To cancel an unwanted track, point to it in the FTS track bar and click on any action button two times. To cancel the entire FTS program, point to the first track in the FTS track bar and click on any action button repeatedly until all the tracks disappear.
Store FTS	SAVE diamond	The Keyboard screen replaces the CD-Audio screen. See "Creating FTS Titles".

- Unloading
Select Stop if the disc is running, then remove the disc using the caddy: on the display the Start-up screen reappears.

Creating FTS Titles

After creating a Favorite Track Selection for a disc, you can compose a title of up to 30 characters for the selection using the Keyboard screen. The title then appears on the CD-Audio screen whenever the disc is loaded.

At the CD-Audio screen, point-and-click on the PROGRAM star, then point-and-click on the SAVE diamond. The CD-Audio screen will change to the Keyboard screen.

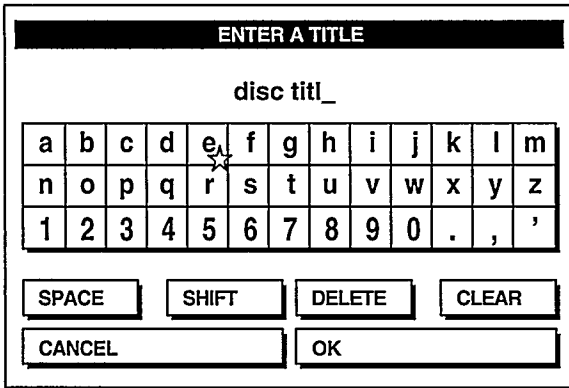

Keyboard Screen

Select each character of the title in turn, using SHIFT to change between upper and lower case characters and SPACE to separate words.

DELETE erases the last selected character. CLEAR erases the complete (or partially complete) title. CANCEL returns to the CD-Audio screen with no title. OK saves the title and returns to the CD-Audio screen.

Push-button control

For basic play control, or for playing discs through a stereo system without using the TV, you can use the buttons on the front panel or a remote control. The PLAY, PAUSE and STOP buttons operate in the same way as the corresponding on-screen functions. The NEXT and PREVIOUS buttons skip one track forward or backward respectively.

CD-Graphics

The CDI 605 is prepared for CD-Graphics, after loading the appropriate software (For update of information fill in and mail registration card.) CD-Graphics disc can be played. When a CD-Audio disc with graphics is loaded, the CD-Graphics screen appears automatically.

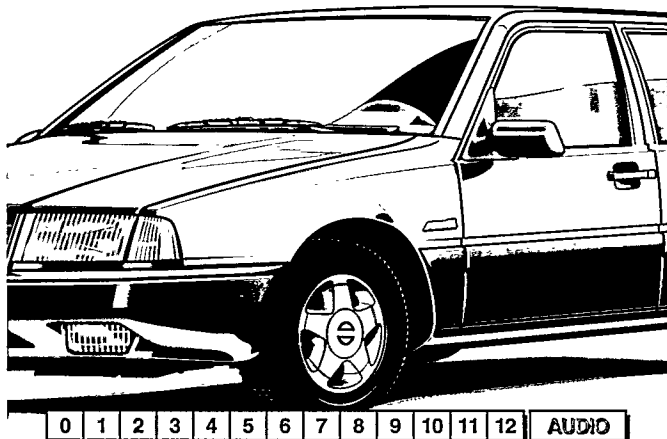

CD-Graphics

To enable or disable picture channels, click on the various numbers. Refer to the instructions that come with the disc for their functions.

To play Audio only, click on the Audio icon. The CD-Audio screen then appears with an additional icon for CD-Graphics.

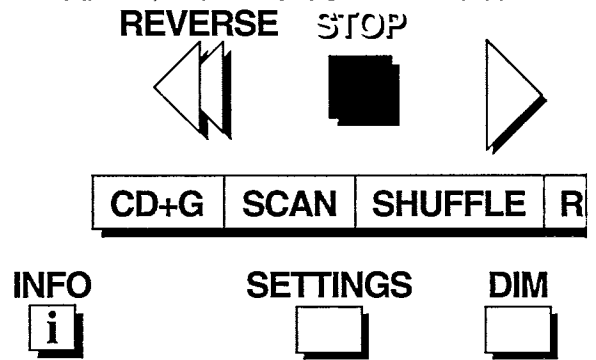

Audio screen

Point-and-click on this icon to obtain the CD-Graphics screen again.

Note 1. Click action button to remove or recall selection bar.

Note 2. Implementation of CD-Graphics might differ depending on player version.

Switching off

- Press the Power On/Off button on the front panel, and check that the Power On indicator goes out.
- Note.** The "Reading Disc" indicator also flashes briefly.
- Switch off the display unit (and audio amplifier, if used).

CLEANING AND DISC CARE

Cleaning

- System: A chamois leather moistened with water is sufficient for cleaning the cabinet. Do not use cleaning agents containing alcohol, spirits, ammonia or abrasives.
- Mouse: Clean the mouse periodically as follows:
 1. Hold the mouse upside down in one hand with the cable pointing away from you.
 2. Using one finger on either side of the ball retainer on the bottom of the mouse, rotate the triangle mark anticlockwise from one circle mark to the other.

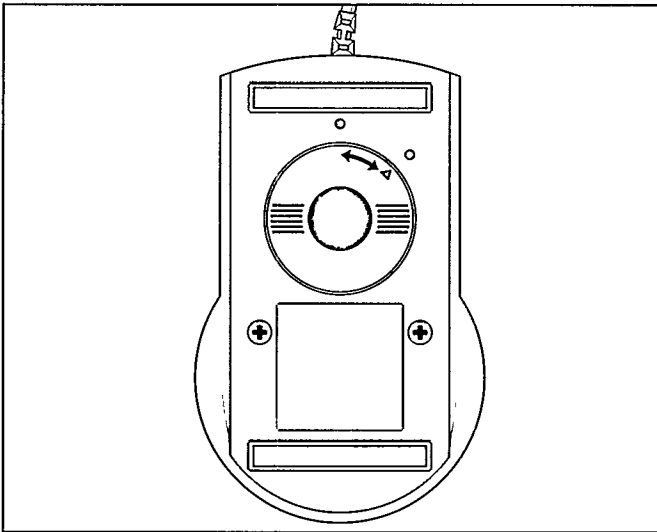

3. Hold the free hand under the mouse to catch the

- retainer and ball, and then turn the mouse over.
4. Use only a clean, soft, dry cloth to wipe the ball clean. Never use cleaning fluid or tissue.
5. Gently wipe inside the mouse housing to remove dust or dirt.
6. Replace the ball in its housing, then re-insert the retainer and lock it by rotating the triangle mark clockwise from one circle mark to the other.

- Care of discs
 - Since the discs are fitted in caddies, it is not normally necessary to clean them unless dirt is suspected as a cause of faulty operation (See Before Requesting Service).
 - Never write on either side of a disc.
 - Never attach stickers to a disc.
 - Keep the playing surface clean. Use a soft lint-free cloth and always wipe the disc in a straight line from centre to edge.

CAUTION: Do not use cleaning agents for conventional records, detergents or abrasive cleaning agents for cleaning discs.

TECHNICAL DATA

AUDIO:	L+R (Cinch connector) 2Vrms typical 10 kOhm. Headphone (6mm Headphone socket) 8 Ohm-2 kOhm, 30 mW at 32 Ohm. Manual volume control.	REMOTE CONTROL: (OPTIONAL)	- Infra-red remote control handset - Wired infra-red remoted control receiver
VIDEO:	NTSC and PAL video out: - RGB (D-sub 9 connector) .7 Vp-p into 75 Ohm. (.3 Vp-p into 75 Ohm sync) - Y/C (Y/C connector) 1 Vp-p into 75 Ohm. - CVBS (Cinch connector) 1 Vp-p into 75 Ohm.	MEMORY:	Total of 5 Mbyte RAM. 1 Mbyte for the Base Case system, 4 Mbyte extended Ram. Expandable to 12 Mbyte via extension slot.
CONTROL PORTS:	Port 1 and 2 (mini DIN 8-pin connector) for pointing device or CD-I keyboard Port 3 (D-sub 9 connector) for RS 232-C based peripherals. Terminal port. Port 4 (D-sub 9 connector) for RS 232-C based peripherals.	POWER SUPPLY:	100-120V or 220-240V +/- 10% selectable 50-60 Hz
EXTENSION SLOT:	One general slot for additional system extensions. This extension slot can also be used to enhance the product (Service mounted) with the Full-Motion Video function.	POWER CONSUMPTION:	approx. 40W (without extensions).
		APPROVALS:	FCC-a, UL 1950. Conforms with VDE (IEC 950), CSA C22.2 No. 220m 1986, NORDIC. US (CDRH) and German (DBD 1046) Laser safety regulations.
		DIMENSIONS:	420 x 90 x 400 mm/16.5 x 3.5 x 15.7 inch. (w x h x d).
		WEIGHT:	7 kg/15.4 lbs.
		PRINTER PORT:	connector: 25 pins D-sub connector standard: centronics compatible function: serves as a printer interface. Fully compatible with the IBM-PC printer port.

SCSI PORT: connector: 50 pins microribbon.
 standard: SCSI-1 (8 bit)
 function: serves as an interface for all SCSI based devices, such as harddisks, CDROMs, magnetic tapes, ...
 Depending on the (resident) software installed, the system (player + ext.) can act as a master (for HARDDISK) as well as slave (CDROM emulation).

ETHERNET: connector: BNC connector (thin wire)
 standard: IEEE 802.3 (thin ethernet)
 function: serves as an interface to all thin wire based LAN's.

5	GND	Signal Ground
6	n.c.	Not Connected
7	RTS	Request To Send
8	+5V	Power supply for the device

Port 2

* Connector: Mini DIN 8 pin

* Pinning:

Pin	Signal	Description
1	n.c.	Not Connected
2	RXD	Received Data
3	TXD	Transmitted Data
4	DTR (*)	Data Terminal Ready
5	GND	Signal Ground
6	CTS	Clear To Send
7	RTS	Request To Send
8	+5V	Power supply for the device

Port 3 & 4

* Connector: D-sub 9

* Pinning:

Pin	Signal	Description
1	n.c.	Not Connected
2	RXD	Received Data
3	TXD	Transmitted Data
4	n.c.	Not Connected
5	GND	Signal Ground
6	n.c.	Not Connected
7	RTS	Request To Send
8	CTS	Clear To Send
9	n.c.	Not Connected

(*) DTR cannot be used as an active handshake signal. It serves as a power supply for some input devices.

Connector signals and pinning

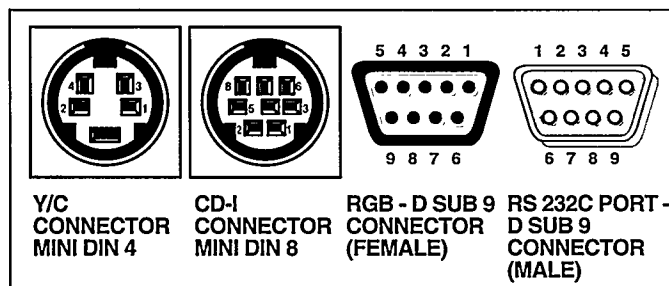

• VIDEO

RGB output:
 * Connector: D-sub 9 pin
 * Pinning:

Pin	Signal
1	GND
2	GND
3	R (Red) analogue
4	G (Green) analogue
5	B(Blue) analogue
6	Mode control = RGB Status (H=RGB)
7	CS (Composite sync.)
8	Reserved
9	Reserved

Y/C output:
 * Connector: Mini DIN 4 pin
 * Pinning:

Pin	Signal
1	Gnd Y
2	Gnd C
3	Y
4	C

• I/O PORTS

Port 1
 * Connector: Mini DIN 8 pin
 * Pinning:

Pin	Signal	Description
1	n.c.	Not Connected
2	RXD	Received Data
3	TXD	Transmitted Data
4	DTR (*)	Data Terminal Ready

• Technical Manual

The Technical Manual is included in the CDI 605 package. Next to this manual for professional system integrators additional data may be required. Please fill-in the registration card to be informed on availability.

BEFORE REQUESTING SERVICE

If it appears that the CD-I system is faulty, first consult this check list. It may be that something simple has been overlooked. Under no circumstances attempt to repair the system; this will invalidate the warranty.

1. After pressing the Power On/Off button, the power indicator does not light.
 - The button was not pressed in sufficiently.
 - One of the plugs on the power cable is not connected or is not making contact.
 - There is no supply at the power socket. Plug in another electrical appliance and check if that works.
2. It takes a very long time before the startup menu appears.
 - In the 605 menu the amount of additional memory is set to '0'.
3. The player does not startup an inserted Disc.
 - Make sure that the CD Driver Selector (it. 33 rear panel) is set to internal.
4. The caddy cannot be loaded into the caddy slot.
 - A disc is already loaded; unload it.
 - The caddy is being held upside down.
5. After loading, the Start up screen does not change.
 - The disc has been inserted upside down in the caddy disc holder.
 - The disc has become dirty. Try cleaning it or using another disc.
 - The disc is defective. Try another disc.
6. No video is being displayed.
 - The display unit is not switched on.
 - The video source selector on the display unit (if used) is incorrectly set.
 - The video connection is faulty.
 - The display unit is not working. If possible, check with another video source.
7. Video is being displayed, but there is no sound.
 - Mute is active.
 - The amplifier* is not switched on.
 - The amplifier* source selector is incorrectly set.
 - The amplifier* or the loudspeakers are not working. Check with another sound source.
 - The audio connections are faulty.

* If used
8. Distorted sound from the Stereo HiFi system.
 - Audio connections made by mistake to the Phono input.
9. The picture is rolling vertically and/or is only in black and white.
 - The 525/625 lines selector is incorrectly set. Switch over and press the Return to Zero ►0◄ key.
10. The cursor is not responding to the mouse.
 - Check the connection cable and press the Return to Zero ►0◄ key.
11. The system does not respond or responds incorrectly, after taking out a disc.
 - Press the Return to ►0◄ key.

REGISTRATION

For a legal description of this CD-I system, record the serial and model numbers in the spaces provided here. These numbers are located on the tab on the back of the system. Please attach your sales receipt to this manual and keep it near the system for quick reference.

PURCHASE DETAILS:

Date of Purchase:
Dealer Purchased From:
Dealer Phone No:
Model No:
Serial No:

Further information regarding this product can be obtained via your international Philips organization, or the address below:

Philips Consumer Electronics B.V.
Interactive Media Systems
P.O. Box 80002
5600 JB Eindhoven
The Netherlands

To be able to give support and distribute new information please fill in registration form and mail it.

GUARANTEE & SERVICE

Philips sell this product subject to the understanding that if any defect in manufacture or material shall appear in it within 90 days from the date of consumer sale, the dealer from whom the product was purchased will arrange for such defect to be rectified without charge. You may have other rights, which vary from country to country or you may require customised service contracts.

Please check your package for inclusions for your country or region, else consult your dealer.



The products and services described herein are not necessarily available in all countries

Due to continuous product improvements this document is subject to change without notice

Printed in Belgium

© PHILIPS 1992 INTERACTIVE MEDIA SYSTEMS.